

# EU-01

## Catalogue

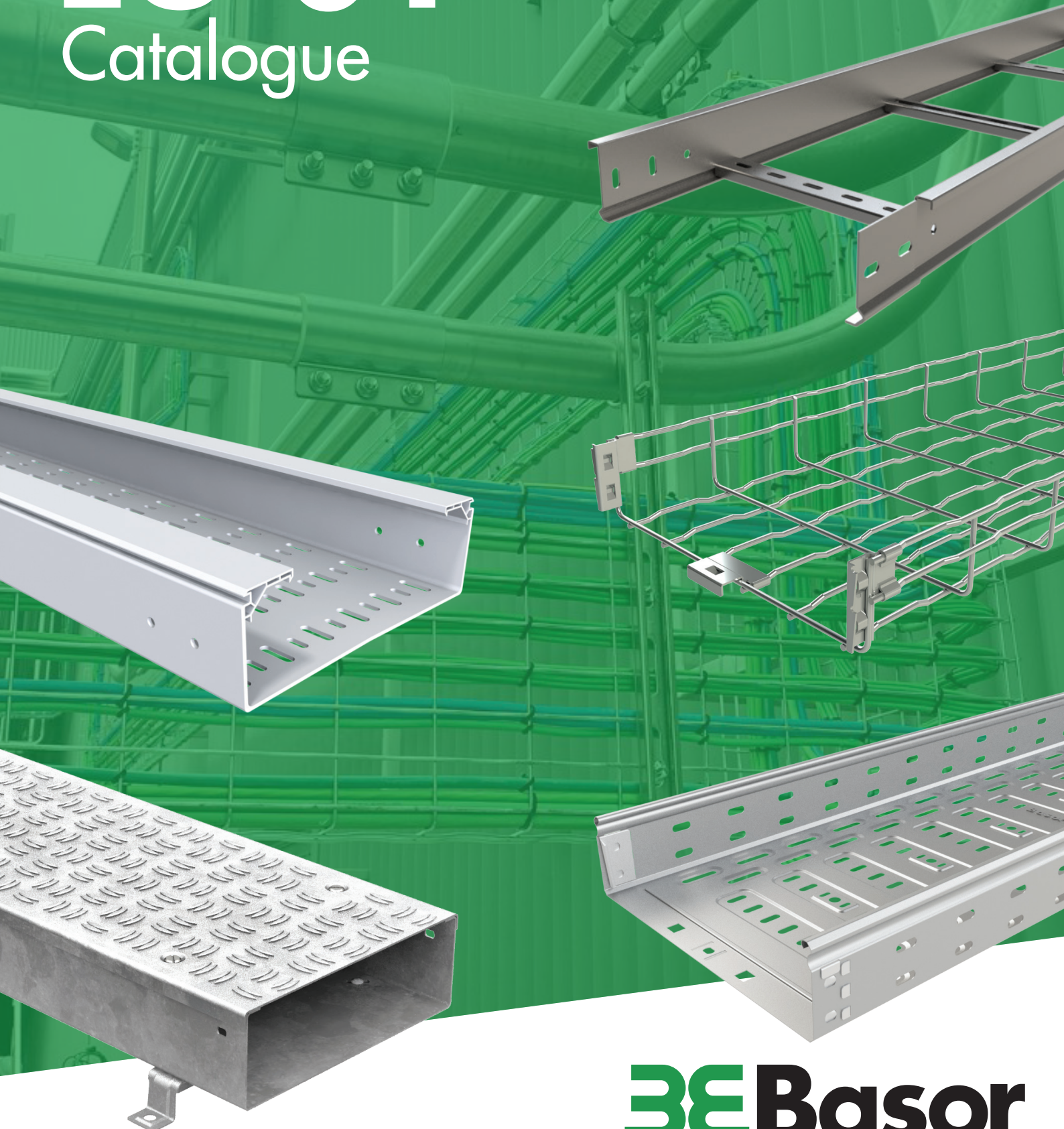

INT. HEADQUARTERS

**BASOR ELECTRIC SA.**

Alcodar Avenue 45-49  
46.701 Gandia (SPAIN)  
T.+34.96.287.6695  
export@basor.com



# Different works, different solutions

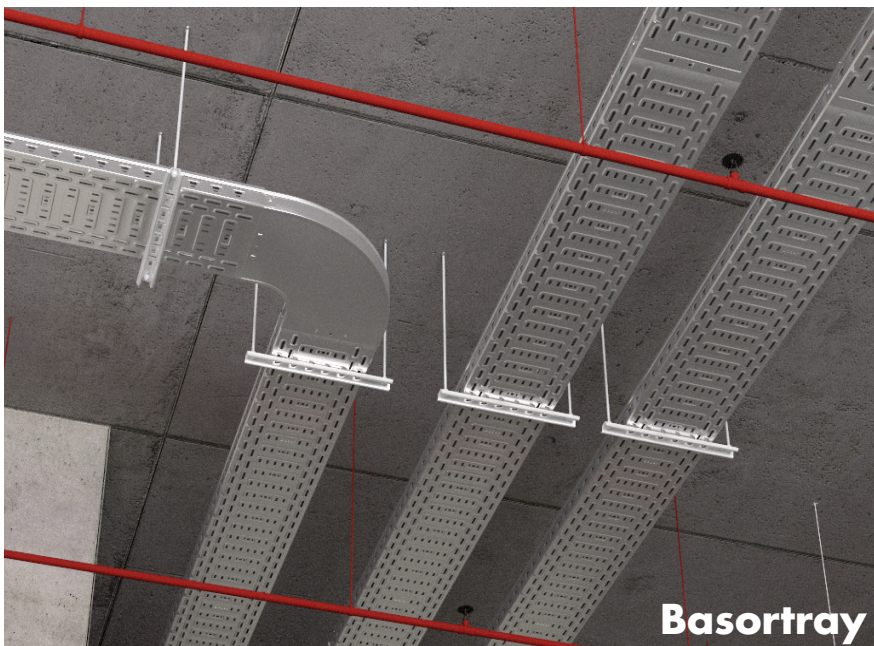
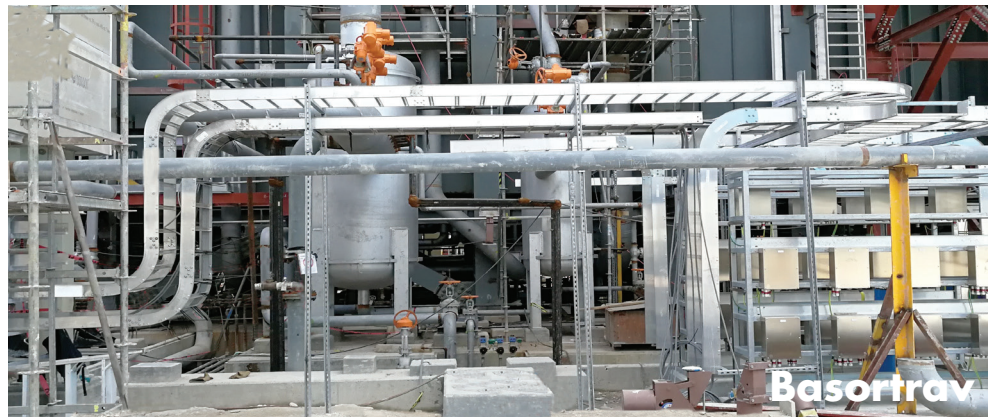



---

## International Catalogue EU-01



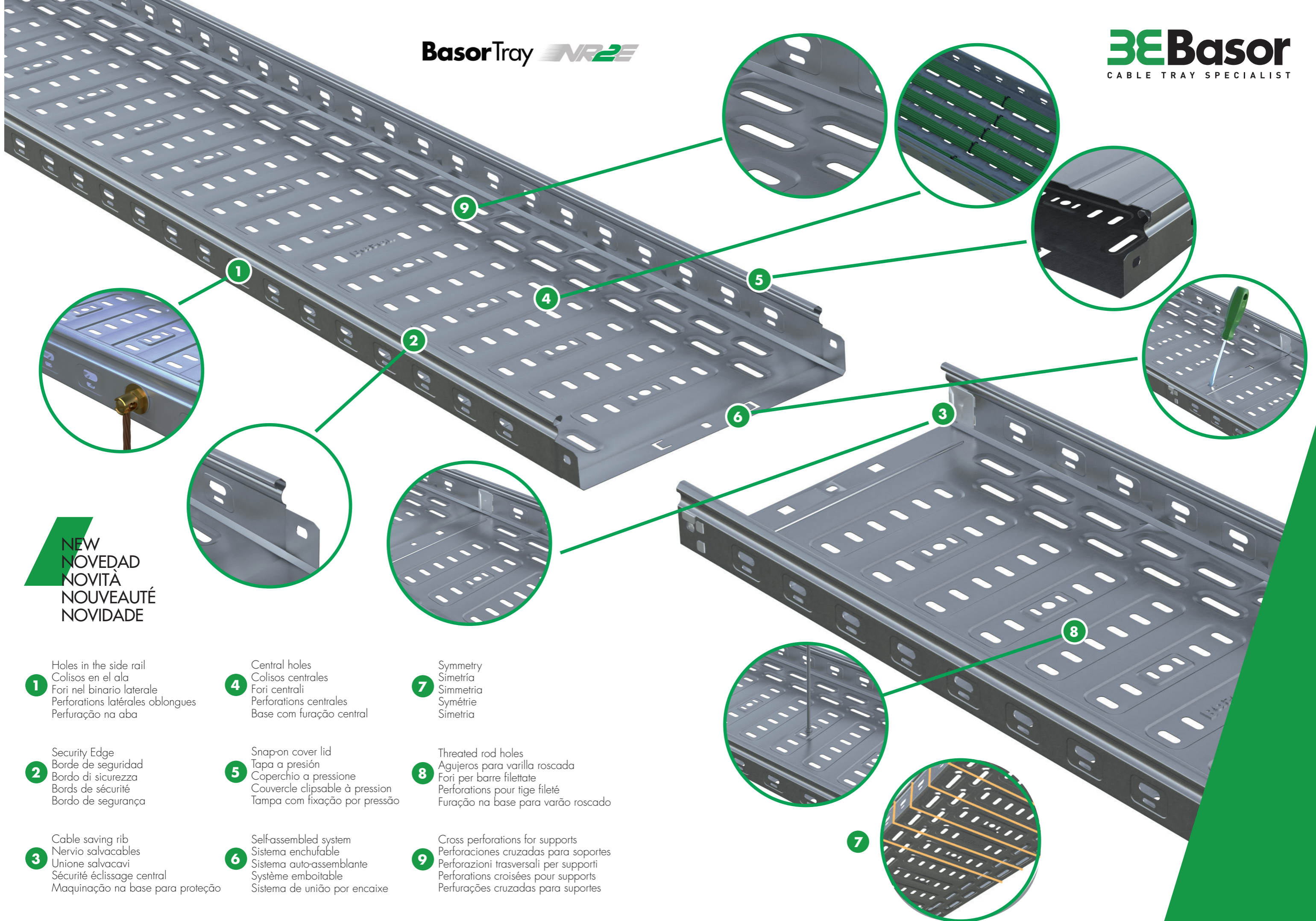

**NEW**  
NOVEDAD  
NOVITÀ  
NOUVEAUTÉ  
NOVIDADE

- 1** Holes in the side rail  
Colisos en el ala  
Fori nel binario laterale  
Perforations latérales oblongues  
Perfuração na aba
- 2** Security Edge  
Borde de seguridad  
Bordo di sicurezza  
Bords de sécurité  
Bordo de segurança
- 3** Cable saving rib  
Nervio salvacables  
Unione salvacavi  
Sécurité éclissage central  
Maquinação na base para proteção
- 4** Central holes  
Colisos centrales  
Fori centrali  
Perforations centrales  
Base com furação central
- 5** Snap-on cover lid  
Tapa a presión  
Coperchio a pressione  
Couvercle clipsable à pression  
Tampa com fixação por pressão
- 6** Self-assembled system  
Sistema enchufable  
Sistema auto-assemblante  
Système emboitable  
Sistema de união por encaixe
- 7** Symmetry  
Simetría  
Simmetria  
Symétrie  
Simetria
- 8** Threaded rod holes  
Agujeros para varilla roscada  
Fori per barre filettate  
Perforations pour tige fileté  
Furação na base para varão roscado
- 9** Cross perforations for supports  
Perforaciones cruzadas para soportes  
Perforazioni trasversali per supporti  
Perforations croisées pour supports  
Perfurações cruzadas para suportes





APILABLE EN VARIOS NIVELES EN VERTICAL/ APILABLE IN VARIOUS LEVELS IN VERTICAL/ APILABLE DANS DIFFERENTS NIVEAUX EN VERTICAL/ APILABLE IN VARI LIVELLI IN VERTICALE/ APILABLE EM VÁRIOS NÍVEIS NA VERTICAL/ APILABLE KÜLÖNBÖZŐ SZINTEKEN FÜGGŐLEGES/ APILABLE IN VERSCHIEDENEN EBENEN IN VERTICAL/ APILABLE В РАЗЛИЧНЫХ УРОВНЕЙ В ВЕРТИКАЛЬНОМ/ APILABLE NA RÓZNYCH POSTOCH VO VERTIKÁLNYCH



ENCAJABLE/ STACKABLE/ EMPILABLE/ IMPILABILE/ STACKABLE/ RAKÁSOLHATÓ/ STAPELBAR/ STACKABLE



CLASIFICACIÓN HILO INCANDESCENTE SEGÚN UNE-EN 60695/ GLOW WIRE CLASSIFICATION UNE-EN 60695/ GLOW WIRE CLASSIFICAZIONE UNE-EN 60695/ GLOW FIO CLASSIFICAÇÃO UNE-EN 60695/ IZZÍTÓSZÁLAS BESOROLÁS UNE-EN 60695/ GLÜHDRAHT KLASSIFIKATION UNE-EN 60695/ РАСКАЛЕННЫЙ ПРОВОД КЛАССИФИКАЦИЯ UNE-EN 60695/ HORÚCOU KLASIFIKÁCIA UNE-EN 60695



SISTEMA PLÁSTICO RESISTENTE A AMBIENTES HÚMEDOS/ SALINOS Y QUÍMICAMENTE AGRESIVOS S/ DIN 8061 E ISO/TR 10358 / PLASTIC SYSTEM RESISTANT TO HUMIDITY/ SALTY AND CHEMICAL ENVIRONMENTS ACCORDING TO DIN 8061 AND ISO/TR 10358 / SYSTÈME PLASTIQUE RÉSISTANT AUX ENVIRONNEMENTS HUMIDES/ SALINS ET CHIMIQUEMENT AGRESSIFS SELON DIN8061 ET ISO/TR 10358 / SISTEMA PLÁSTICO RESISTENTE A AMBIENTES HÚMIDOS/ SALINOS E QUÍMICAMENTE AGRESSIVOS/ SEGUNDO NORMA S/ DIN 8061 E ISSO/TR 10358 / PÁRÁS SÓS KÉMIAI KÖRNYEZETBEN ALKALMAZHATÓ DIN 8061/ISO/TR 10358 / PLASTISCHES SYSTEM/ RESISTENZ IN FEUCHTEM/ SALZHALTIGEM UND CHEMISCHEN MEDIUM S/ DIN 8061 E ISO/TR 10358 / ПОКАЗАТЕЛЬ УСТОЙЧИВОСТИ ПЛАСТИКОВОЙ СИСТЕМЫ К ВЛАЖНОСТИ, НАХОЖДЕНИЮ В СОЛЕНОЙ ИЛИ ХИМИЧЕСКОЙ СРЕДЕ УКАЗАН В СООТВЕТСТВИИ СО СТАНДАРТОМ DIN 8061 И ISO/TR 10358 / PLAST.SYSTÉM ODOLNÝ VŮČI VLHKOSTI, SLANÉMU A CHEMICKÉMU PROSTŘEDÍ DLE DIN 8061 A ISO / TR 10358

PG

ACERO GALVANIZADO SENDZIMIR / PRE GALVANISED STEEL / ACIER À GALVANISATION SENDZIMIR / AÇO COM GALVANIZAÇÃO SENDZIMIR / SZALAGHORGANYZOTT / STAHL SENDZIMIR VERZINKT / ПРЕДВАРИТЕЛЬНО ГАЛЬВАНИЗИРОВАННАЯ СТАЛЬ / SENDZIMIROVÉ ZINKOVÁNO

HDG85

ACERO GALVANIZADO EN CALIENTE CON ESPESOR MÍNIMO DE 85 µm / HOT DIP GALVANISED WITH MINIMUM THICKNESS OF 85 µm / ACIER GALVANISÉ À CHAUD D'UNE ÉPAISSEUR MINIMALE DE 85 µm / AÇO COM GALVANIZAÇÃO A QUENTE APÓS MAQUINAÇÃO COM ESPESURA MÍNIMA DE 85 µm / TŰZIHORGANYZOTT AZ MINIMÁLIS VASTAGSÁGA 85 µm / STAHL HOT DIP MIT EINER MINDESTDICKE 85 µm / ГОРЯЧАЯ ГАЛЬВАНИЗАЦИЯ ТОЛЩИНОЙ НЕ МЕНЕЕ 85 µm / ŽÁROVÉ ZINKOVÁNO O MINIMÁLNI TLOUŠŤCE 85 µm

HDG

ACERO GALVANIZADO EN CALIENTE / HOT DIP GALVANISED / ACIER GALVANISÉ À CHAUD / AÇO COM GALVANIZAÇÃO A QUENTE APÓS MAQUINAÇÃO / TŰZIHORGANYZOTT / STAHL HOT DIP / ГОРЯЧАЯ ГАЛЬВАНИЗАЦИЯ / ŽÁROVÉ ZINKOVÁNO

EZ 1000

ACERO ELECTROZINCADO CON RESISTENCIA MÍNIMA A LA CORROSIÓN DE 1000 H / ELECTROZINC COATING WITH MINIMAL RESISTANCE TO CORROSION OF 1000 H / ACIER ELECTROZINGUÉ AVEC RÉSISTANCE À LA CORROSION MINIMAL DE 1000 H / AÇO ELECTROZINCADO COM RESISTÊNCIA MÍNIMA À CORROSAO 1000 H / ELEKTROGALVANIKUS BEVONAT MINIMÁLIS ELLENÁLLÁSSAL KORRÓZIÓ 1000 H / STAHL ELEKTROLYTISCH VERZINKT MIT MINIMALEM KORROSIONSBESTÄNDIGKEIT VON 1000 H / ОЦИНКОВАННОЕ ПОКРЫТИЕ С МИНИМАЛЬНОЙ КОРРОЗИОСТОЙКОСТИ 1000 H / GALVANICKY ZINKOVÁNO S MINIMÁLNI ODOLNOST PROTI KOROZI ČINÍ 1000 H

EZ

ACERO ELECTROZINCADO / ELECTROZINC COATING / ACIER ELECTROZINGUÉ / AÇO ELECTROZINCADO / ELEKTROGALVANIKUS BEVONAT / STAHL ELEKTROLYTISCH VERZINKT / ОЦИНКОВАННОЕ ПОКРЫТИЕ / GALVANICKY ZINKOVÁNO

i304

ACERO INOXIDABLE AISI 304 / STAINLESS STEEL AISI 304 / ACIER INOXIDABLE AISI 304 / AÇO INOXIDÁVEL AISI 304 / ROZSDAMENTES INOX 304 / EDELSTAHL AISI 304 / НЕРЖАВЕЮЩАЯ СТАЛЬ AISI 304 / NEREZOVÁ OCEL AISI 304

i316

ACERO INOXIDABLE AISI 316 / STAINLESS STEEL AISI 316 / ACIER INOXIDABLE AISI 316 / AÇO INOXIDÁVEL AISI 316 / ROZSDAMENTES INOX 316 / EDELSTAHL AISI 316 / НЕРЖАВЕЮЩАЯ СТАЛЬ AISI 316 / NEREZOVÁ OCEL AISI 316

AL

ALUMINIO SEMIDURO / SEMI-RIGID ALUMINIUM / ALUMINIUM DEMI-DUR / ALLUMINIO SEMI-RIGIDO / ALUMÍNIO SEMIDURO / FÉLKEMÉNY ALUMINIUM / HALBSTARRER ALUMINIUM / ПОЛУЖЕСТКИЙ АЛЮМИНИЙ / HLINÍKOVÉ PROVEDENÍ

GSP

ACERO GALVANIZADO SENDZIMIR + PINTURA-POLYESTER / PRE-GALVANISED STEEL + /POLYESTHER PAINTING / ACIER GALVANISÉ SENDZIMIR+ PEINTURE POLYESTER / ACCIAIO GALVANIZZATO SENDZIMIR + VERNICIATURA POLIESTERE / AÇO GALVANIZADO SENDZIMIR + PINTURA POLYESTER / SZALAGHORGANYZOTT ACÉL+ BEVONAT / STAHL SENDZIMIR VERZINKT + POLYESTER FARBE / ПРЕДВАРИТЕЛЬНО ГАЛЬВАНИЗИРОВАННАЯ СТАЛЬ + ПОКРЫТИЕ СМОЛА/ПОЛИЭСТР / POZINKOVANÁ OCEL + POLYESTEROVÁ BARVA

PVC M1

POLIMERO TERMOPLÁSTICO PVC M1 / THERMOPLASTIC POLYMER PVC M1 / POLYMÈRE THERMOPLASTIQUE PVC M1 / POLÍMERO TERMOPLÁSTICO PVC M1 / POLIMER PVC M1 UV / THERMOPLASTISCHES POLYMER PVC M1 / ПВХ M1 ТЕРМОПЛАСТИЧНЫЙ ПОЛИМЕР / TERMOPLASTICKÝ POLYMER PVC M1

UVM1

POLIMERO TERMOPLÁSTICO PVC M1 RESISTENTE RADIACIÓN UV / THERMOPLASTIC POLYMER PVC M1 UV RESISTENT RADIATION / POLYMÈRE THERMOPLASTIQUE PVC M1 UV RÉSISTANT À LA RADIATION / POLÍMERO TERMOPLÁSTICO PVC M1 RADIAZIONE RESISTENT UV / POLIMER PVC M1 UV RADIAÇÃO RESISTENTE / THERMOPLASTISCHES POLYMER / PVC STRAHLUNGSBESTÄNDIG / ТЕРМОПЛАСТИЧНЫЙ ПОЛИМЕР ПВХ SUGÁRZÁSNAK ELLENÁLLÓ / TERMOPLASTICKÝ POLYMER PVC M1 ZÁŘENÍ ODOLNÝ UV

PVC 7035

POLIMERO TERMOPLÁSTICO PVC / THERMOPLASTIC POLYMER PVC / POLYMÈRE THERMOPLASTIQUE PVC / POLÍMERO TERMOPLÁSTICO PVC / POLIMER PVC / THERMOPLASTISCHES POLYMER PVC / ТЕРМОПЛАСТИЧНЫЙ ПОЛИМЕР ПВХ / TERMOPLASTICKÝ POLYMER PVC

RLH 7035

POLIMERO TERMOPLÁSTICO LIBRE DE HALOGENOS / THERMOPLASTIC HALOGEN FREE POLYMER / POLYMÈRE THERMOPLASTIQUE SANS HALOGÈNE / POLÍMERO TERMOPLÁSTICO LIVRE DE HALOGÉNEOS / POLIMER HALOGÉNMENTES MŰANYAG / THERMOPLASTISCHES POLYMER HALOGENFREI RLH 7035 / ТЕРМОПЛАСТИЧНЫЙ ПОЛИМЕР, НЕ СОДЕРЖАЩИЙ ГАЛОГЕН / BEZHALOGENOVÝ TERMOPLASTICKÝ POLYMER PVC

CLH 7035

POLIMERO TERMOPLÁSTICO LIBRE DE HALOGENOS CURVABLE CON APLICACIÓN DE CALOR CLH7035 / THERMOPLASTIC POLYMER/ BENDABLE WITH HEAT CLH7035 / POLYMÈRE THERMOPLASTIQUE SANS HALOGÈNE DÉFORMABLE À CHAUD / POLÍMERO TERMOPLÁSTICO LIVRE DE HALOGÉNEOS CURVÁVEL COM APLICAÇÃO DE CALOR CLH7035 / HALOGÉNMENTES MELEGEN HAJLÍTHATÓ / HALOGENFREIES BIEGBARES THERMOPLASTISCHES POLYMER MIT WÄRMEBEHANDLUNG CHL7035 / ТЕРМОПЛАСТИЧНЫЙ ПОЛИМЕР CLH7035, СГИБАЕМЫЙ ПРИ ПОМОЩИ ТЕПЛА / BEZHALOGENOVÝ TERMOPLASTICKÝ POLYMER, TERPELNĚ OHEBNÝ CLH7035





PAFV

POLIAMIDA REFORZADA CON FIBRA DE VIDRIO / POLYAMIDE REINFORCED WITH FIBERGLASS / POLYAMIDE AVEC FIBRE DE VERRE RENFORCÉE / POLIAMMIDE CON VETRORESINA RINFORZATA / POLIAMIDA COM FIBRA DE VIDRO REFORÇADA / POLIAMID AZ ÜVEGSZÁL ERŐSÍTÉSŰ / POLYAMID MIT VERSTÄRKTEM FIBERGLAS / ПОКРЫТИЕ С АРМИРОВАННОГО СТЕКЛОПЛАСТИКА / POLYAMID MÁ VYZTUŽENÉ SKELNÝMI VLÁKNY

LTN

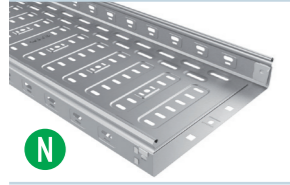
LATÓN / BRASS / BRASS / OTTONE / BRONZE / BRASS / BRASS / ЛАТУНЬ / MOSAZ

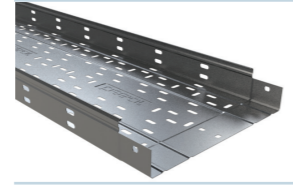
**BasorTRAY | SCM**

NR2E	ERE50	ERE / MRE	FRE	10
				



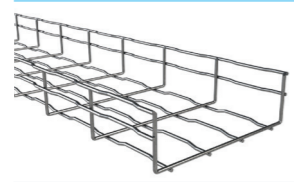



**BasorFIL | SCM**

BF2R	BFR	44
		

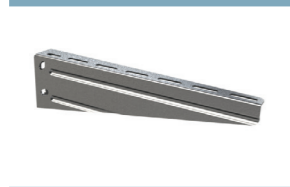



**BasorTRAV | SCM**

FE / FE2	60
	

**BasorSUPPORT | SCM**

SCR	SPL	SV	74
			
C-PC   KLPC	SHST	SP3S	
			

**BasorPLAST | SCP**

BPE	SHG	SHGR + 2 SHG	SVG	96
				

**BasorCANAL | SCE**

WT	106
	

**BasorTUB**

RE1250 / R1250	116
	

**BasorFIX | ACC**

GVV2	P41	RA35		120
				
SBZ			TT	
				



**BasorTRAY**  
NR2E

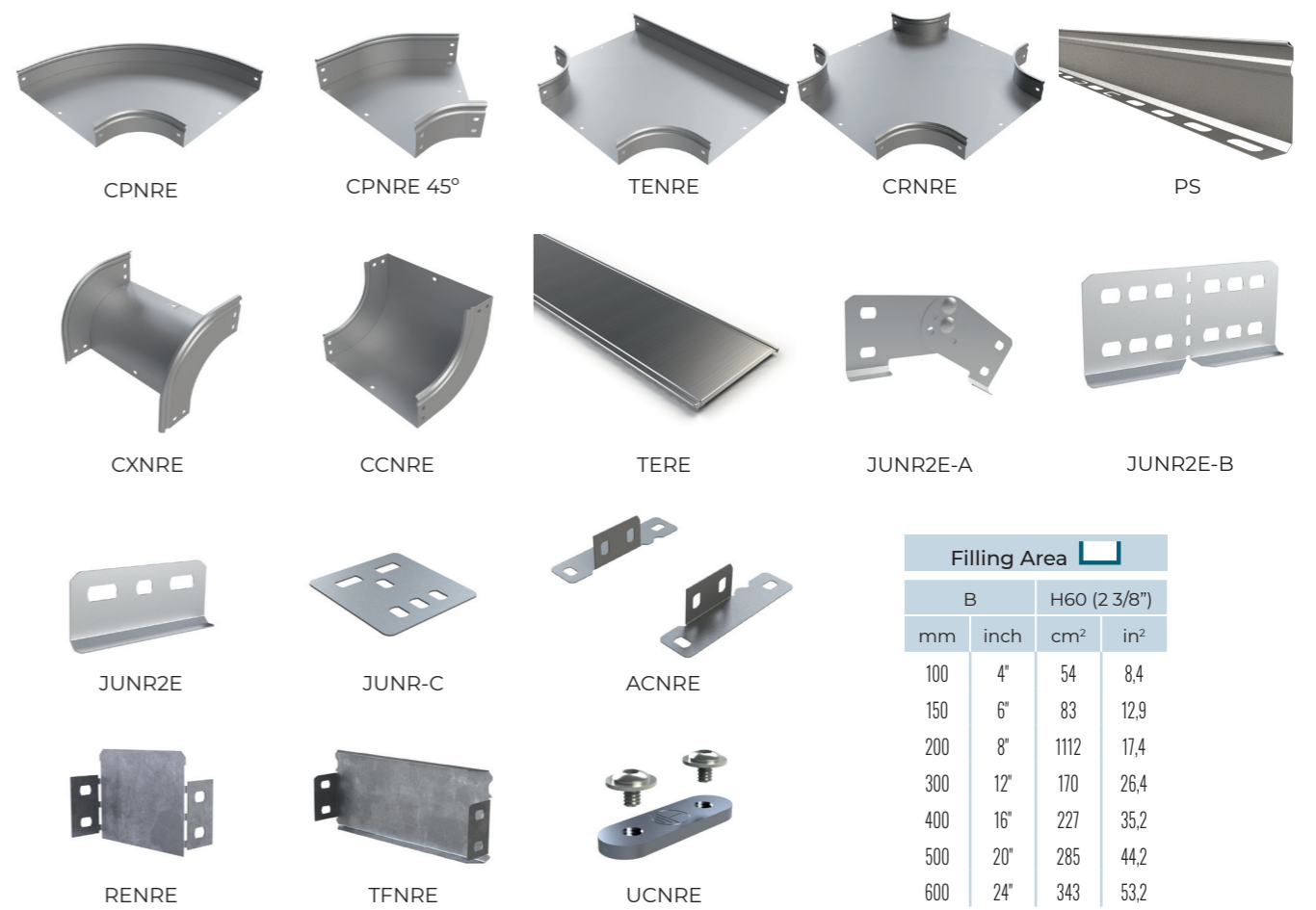
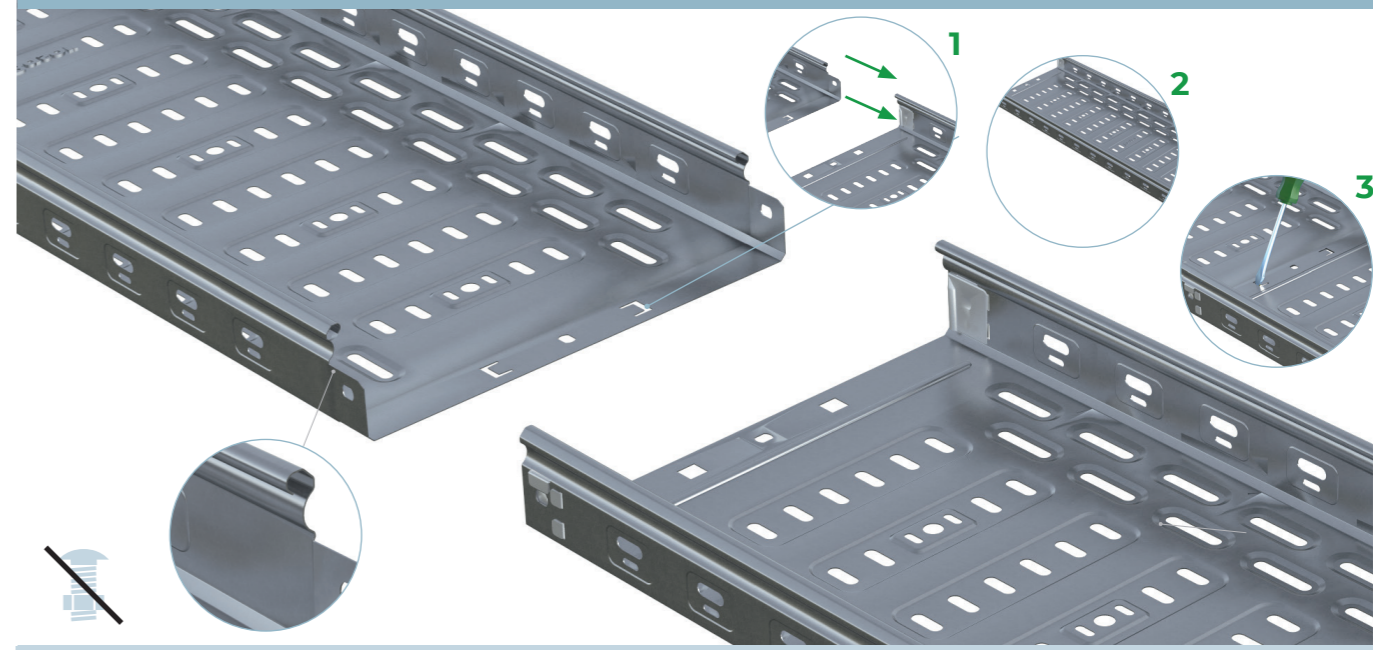

Filling Area			
B		H60 (2 3/8")	
mm	inch	cm <sup>2</sup>	in <sup>2</sup>
100	4"	54	8,4
150	6"	83	12,9
200	8"	112	17,4
300	12"	170	26,4
400	16"	227	35,2
500	20"	285	44,2
600	24"	343	53,2



NR2E H60

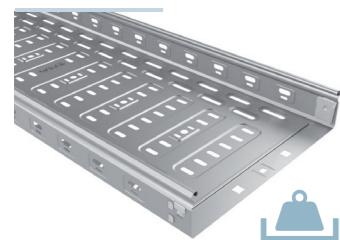

L = 3 m (10 ft)

	B		H		PG	
	mm	inch	mm	inch	REF.	MOQ
NR2E 100X60	100	4"	60	2 3/8"	223988	24 M
NR2E 150X60	150	6"	60	2 3/8"	223989	24 M
NR2E 200X60	200	8"	60	2 3/8"	223990	12 M
NR2E 300X60	300	12"	60	2 3/8"	223991	12 M
NR2E 400X60	400	16"	60	2 3/8"	223992	6 M
NR2E 500X60	500	20"	60	2 3/8"	223993	6 M
NR2E 600X60	600	24"	60	2 3/8"	223994	6 M

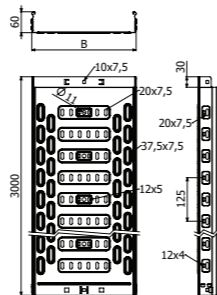

NE2E H60

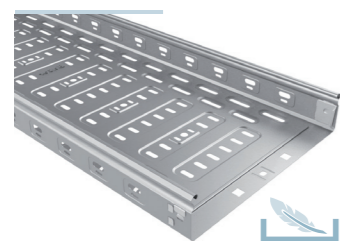

L = 3 m (10 ft)

	B		H		PG	
	mm	inch	mm	inch	REF.	MOQ
NE2E 100X60	100	4"	60	2 3/8"	224333	24 M
NE2E 150X60	150	6"	60	2 3/8"	224334	24 M
NE2E 200X60	200	8"	60	2 3/8"	224335	12 M
NE2E 300X60	300	12"	60	2 3/8"	224336	12 M

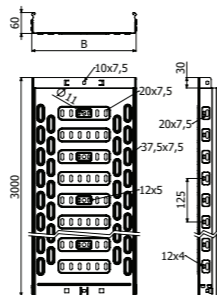

NR2E H75

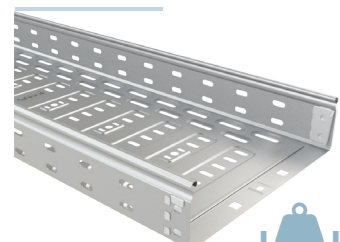

L = 3 m (10 ft)

	B		H		PG	
	mm	inch	mm	inch	REF.	MOQ
NR2E 100X75	100	4"	75	3"	223995	24 M
NR2E 150X75	150	6"	75	3"	223996	24 M
NR2E 200X75	200	8"	75	3"	223997	12 M
NR2E 300X75	300	12"	75	3"	223998	12 M
NR2E 400X75	400	16"	75	3"	223999	6 M
NR2E 500X75	500	20"	75	3"	224000	6 M
NR2E 600X75	600	24"	75	3"	224001	6 M

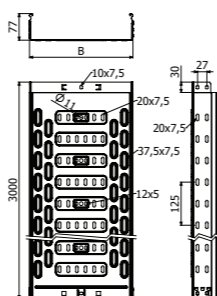

NR2E-C H75



L = 3 m (10 ft)

	B		H		PG	
	mm	inch	mm	inch	REF.	MOQ
NR2E-C 100X75	100	4"	75	3"	224002	24 M
NR2E-C 150X75	150	6"	75	3"	224003	24 M
NR2E-C 200X75	200	8"	75	3"	224004	12 M
NR2E-C 300X75	300	12"	75	3"	224005	12 M
NR2E-C 400X75	400	16"	75	3"	224006	6 M
NR2E-C 500X75	500	20"	75	3"	224007	6 M
NR2E-C 600X75	600	24"	75	3"	224008	6 M

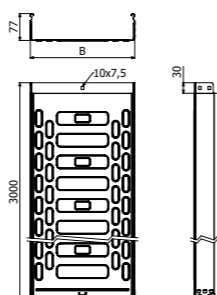

1/100 x B1 (204356)

TNR2E

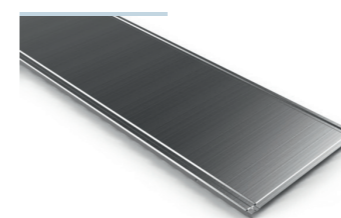

L = 3 m (10 ft)

	B		PG	
	mm	inch	REF.	MOQ
TNR2E 100 3M	100	4"	224841	24 M
TNR2E 150 3M	150	6"	224842	24 M
TNR2E 200 3M	200	8"	224843	24 M
TNR2E 300 3M	300	12"	224844	18 M
TNR2E 400 3M	400	16"	224845	12 M
TNR2E 500 3M	500	20"	224846	8 M
TNR2E 600 3M	600	24"	224847	8 M

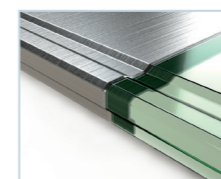
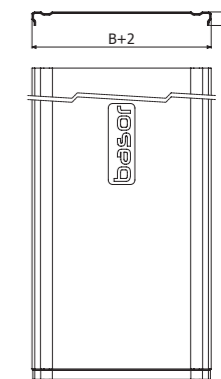

PTNRE



	H		i304		i316
	mm	inch	REF.	MOQ	
PTNRE 100x60	100	4"	224848	1 U	150 .. 600
PTNRE 150-600x60	150	6"	224849	1 U	
PTNRE 100x75	100	4"	224850	1 U	40 48
PTNRE 150-600x75	150	6"	224851	1 U	



4 x PTNRE => 1 x TNR2E

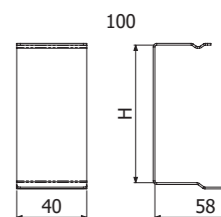

## CPNRE 90° H60

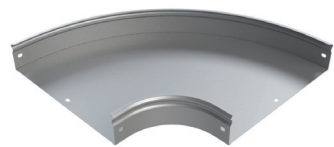

	B		H		PG	
	mm	inch	mm	inch	REF.	MOQ
CPNRE 90° 100X60	100	4"	60	2 3/8"	224035	1 U
CPNRE 90° 150X60	150	6"	60	2 3/8"	224036	1 U
CPNRE 90° 200X60	200	8"	60	2 3/8"	224037	1 U
CPNRE 90° 300X60	300	12"	60	2 3/8"	224038	1 U
CPNRE 90° 400X60	400	16"	60	2 3/8"	224039	1 U
CPNRE 90° 500X60	500	20"	60	2 3/8"	224040	1 U
CPNRE 90° 600X60	600	24"	60	2 3/8"	224041	1 U

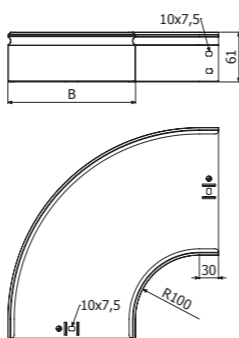

B = 100>300 2x JUNRE H60 (224217) + 4/100 x B1 (204356 EZ)  
B = 400>600 2x JUNRE H60 (224217) + 1x JUNRE-C (224252) + 6/100 x B1 (204356 EZ)

## CPNRE 90° H75

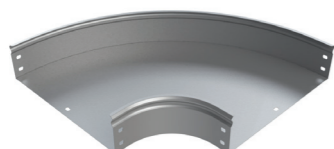

	B		H		PG	
	mm	inch	mm	inch	REF.	MOQ
CPNRE 90° 100X75	100	4"	75	3"	224042	24 M
CPNRE 90° 150X75	150	6"	75	3"	224043	24 M
CPNRE 90° 200X75	200	8"	75	3"	224044	12 M
CPNRE 90° 300X75	300	12"	75	3"	224045	12 M
CPNRE 90° 400X75	400	16"	75	3"	224046	6 M
CPNRE 90° 500X75	500	20"	75	3"	224047	6 M
CPNRE 90° 600X75	600	24"	75	3"	224048	6 M

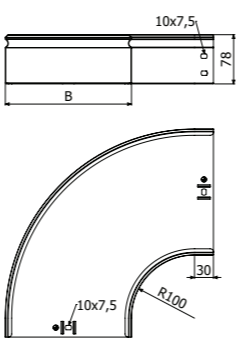

B = 100>300 2x JUNRE H75 (224218) + 8/100 x B1 (204356 EZ)  
B = 400>600 2x JUNRE H75 (224218) + 1x JUNRE-C (224252) + 10/100 x B1 (204356 EZ)

## TCPNRE 90°



	B		PG	
	mm	inch	REF.	MOQ
TCPNRE 90° 100	100	4"	224063	1 U
TCPNRE 90° 150	150	6"	224064	1 U
TCPNRE 90° 200	200	8"	224065	1 U
TCPNRE 90° 300	300	12"	224066	1 U
TCPNRE 90° 400	400	16"	224067	1 U
TCPNRE 90° 500	500	20"	224068	1 U
TCPNRE 90° 600	600	24"	224069	1 U

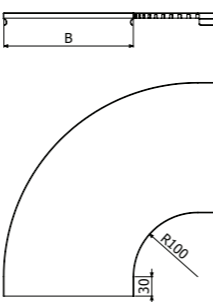

## CCNRE 90° H60

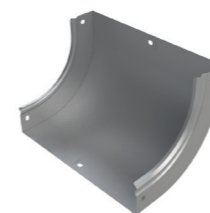

	B		H		PG	
	mm	inch	mm	inch	REF.	MOQ
CCNRE 90° 100X60	100	4"	60	2 3/8"	224077	1 U
CCNRE 90° 150X60	150	6"	60	2 3/8"	224078	1 U
CCNRE 90° 200X60	200	8"	60	2 3/8"	224079	1 U
CCNRE 90° 300X60	300	12"	60	2 3/8"	224080	1 U
CCNRE 90° 400X60	400	16"	60	2 3/8"	224081	1 U
CCNRE 90° 500X60	500	20"	60	2 3/8"	224082	1 U
CCNRE 90° 600X60	600	24"	60	2 3/8"	224083	1 U

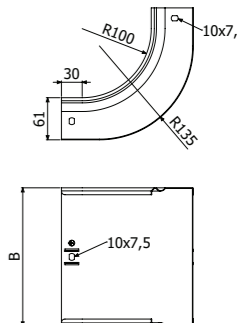

B = 100>300 2x JUNRE H60 (224217) + 4/100 x B1 (204356 EZ)  
B = 400>600 2x JUNRE H60 (224217) + 1x JUNRE-C (224252) + 6/100 x B1 (204356 EZ)

## CCNRE 90° H75

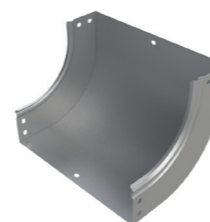

	B		H		PG	
	mm	inch	mm	inch	REF.	MOQ
CCNRE 90° 100X75	100	4"	75	3"	224084	24 M
CCNRE 90° 150X75	150	6"	75	3"	224085	24 M
CCNRE 90° 200X75	200	8"	75	3"	224086	12 M
CCNRE 90° 300X75	300	12"	75	3"	224087	12 M
CCNRE 90° 400X75	400	16"	75	3"	224088	6 M
CCNRE 90° 500X75	500	20"	75	3"	224089	6 M
CCNRE 90° 600X75	600	24"	75	3"	224090	6 M

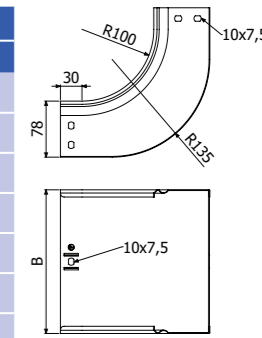

B = 100>300 2x JUNRE H75 (224218) + 8/100 x B1 (204356 EZ)  
B = 400>600 2x JUNRE H75 (224218) + 1x JUNRE-C (224252) + 10/100 x B1 (204356 EZ)

## TCCNRE 90°

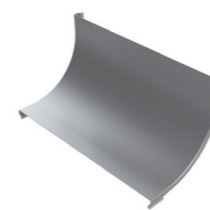

	B		PG	
	mm	inch	REF.	MOQ
TCCNRE 90° 100	100	4"	224105	1 U
TCCNRE 90° 150	150	6"	224106	1 U
TCCNRE 90° 200	200	8"	224107	1 U
TCCNRE 90° 300	300	12"	224108	1 U
TCCNRE 90° 400	400	16"	224109	1 U
TCCNRE 90° 500	500	20"	224110	1 U
TCCNRE 90° 600	600	24"	224111	1 U

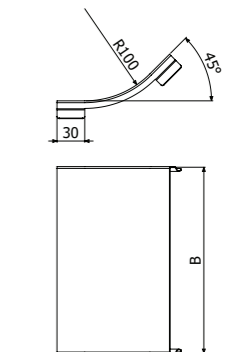

## CXNRE 90° H60

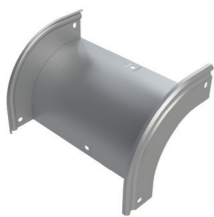

	B		H		PG	
	mm	inch	mm	inch	REF.	MOQ
CXNRE 90° 100X60	100	4"	60	2 3/8"	224119	1 U
CXNRE 90° 150X60	150	6"	60	2 3/8"	224120	1 U
CXNRE 90° 200X60	200	8"	60	2 3/8"	224121	1 U
CXNRE 90° 300X60	300	12"	60	2 3/8"	224122	1 U
CXNRE 90° 400X60	400	16"	60	2 3/8"	224123	1 U
CXNRE 90° 500X60	500	20"	60	2 3/8"	224124	1 U
CXNRE 90° 600X60	600	24"	60	2 3/8"	224125	1 U

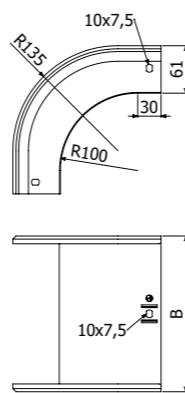

B = 100>300 2x JUNRE H60 (224217) + 4/100 x B1 (204356 EZ)  
 B = 400>600 2x JUNRE H60 (224217) + 1x JUNRE-C (224252) + 6/100 x B1 (204356 EZ)

## TCXNRE 90° H60

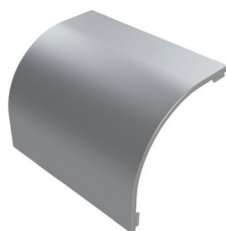

	B		PG	
	mm	inch	REF.	MOQ
TCXNRE 90° 100	100	4"	224147	1 U
TCXNRE 90° 150	150	6"	224148	1 U
TCXNRE 90° 200	200	8"	224149	1 U
TCXNRE 90° 300	300	12"	224150	1 U
TCXNRE 90° 400	400	16"	224151	1 U
TCXNRE 90° 500	500	20"	224152	1 U
TCXNRE 90° 600	600	24"	224153	1 U

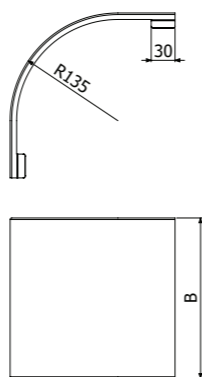

## CXNRE 90° H75

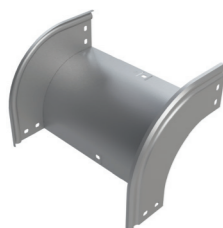

	B		H		PG	
	mm	inch	mm	inch	REF.	MOQ
CXNRE 90° 100X75	100	4"	75	3"	224126	24 M
CXNRE 90° 150X75	150	6"	75	3"	224127	24 M
CXNRE 90° 200X75	200	8"	75	3"	224128	12 M
CXNRE 90° 300X75	300	12"	75	3"	224129	12 M
CXNRE 90° 400X75	400	16"	75	3"	224130	6 M
CXNRE 90° 500X75	500	20"	75	3"	224131	6 M
CXNRE 90° 600X75	600	24"	75	3"	224132	6 M

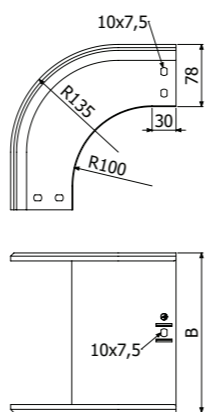

B = 100>300 2x JUNRE H75 (224218) + 8/100 x B1 (204356 EZ)  
 B = 400>600 2x JUNRE H75 (224218) + 1x JUNRE-C (224252) + 10/100 x B1 (204356 EZ)

## TCXNRE 90° H75

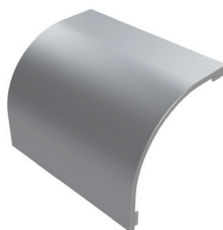

	B		PG	
	mm	inch	REF.	MOQ
TAPA 90° TCXNRE 100	100	4"	224154	24 M
TAPA 90° TCXNRE 150	150	6"	224155	24 M
TAPA 90° TCXNRE 200	200	8"	224156	24 M
TAPA 90° TCXNRE 300	300	12"	224157	18 M
TAPA 90° TCXNRE 400	400	16"	224158	12 M
TAPA 90° TCXNRE 500	500	20"	224159	8 M
TAPA 90° TCXNRE 600	600	24"	224160	8 M

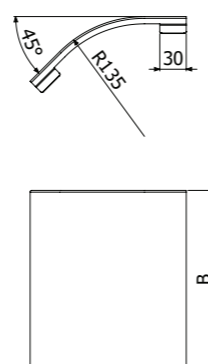

## TENRE H60

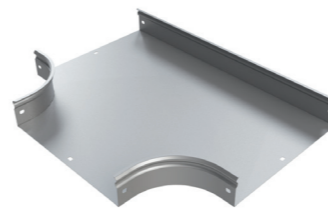

	B		H		PG	
	mm	inch	mm	inch	REF.	MOQ
TENRE 100X60	100	4"	60	2 3/8"	224175	1 U
TENRE 150X60	150	6"	60	2 3/8"	224176	1 U
TENRE 200X60	200	8"	60	2 3/8"	224177	1 U
TENRE 300X60	300	12"	60	2 3/8"	224178	1 U
TENRE 400X60	400	16"	60	2 3/8"	224179	1 U
TENRE 500X60	500	20"	60	2 3/8"	224180	1 U
TENRE 600X60	600	24"	60	2 3/8"	224181	1 U

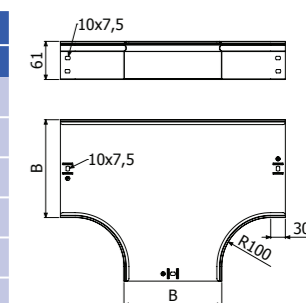

B = 100>300 2x JUNRE H60 (224217) + 4/100 x B1 (204356 EZ)  
 B = 400>600 2x JUNRE H60 (224217) + 1x JUNRE-C (224252) + 6/100 x B1 (204356 EZ)

## TENRE H75

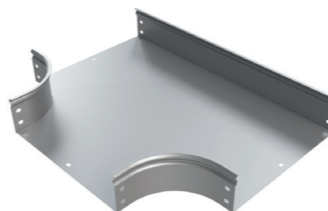

	B		H		PG	
	mm	inch	mm	inch	REF.	MOQ
TENRE 100X75	100	4"	75	3"	224182	24 M
TENRE 150X75	150	6"	75	3"	224183	24 M
TENRE 200X75	200	8"	75	3"	224184	12 M
TENRE 300X75	300	12"	75	3"	224185	12 M
TENRE 400X75	400	16"	75	3"	224186	6 M
TENRE 500X75	500	20"	75	3"	224187	6 M
TENRE 600X75	600	24"	75	3"	224188	6 M

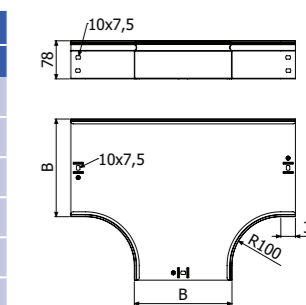

B = 100>300 2x JUNRE H75 (224218) + 8/100 x B1 (204356 EZ)  
 B = 400>600 2x JUNRE H75 (224218) + 1x JUNRE-C (224252) + 10/100 x B1 (204356 EZ)

## TTNRE

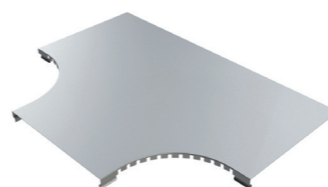

	B		PG	
	mm	inch	REF.	MOQ
TTNRE 100	100	4"	224189	1 U
TTNRE 150	150	6"	224190	1 U
TTNRE 200	200	8"	224191	1 U
TTNRE 300	300	12"	224192	1 U
TTNRE 400	400	16"	224193	1 U
TTNRE 500	500	20"	224194	1 U
TTNRE 600	600	24"	224195	1 U

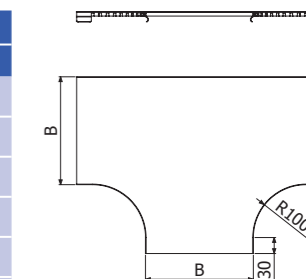

## CRNRE H60

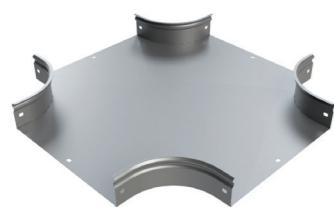

	B		H		PG	
	mm	inch	mm	inch	REF.	MOQ
CRNRE 100X60	100	4"	60	2 3/8"	224196	1 U
CRNRE 150X60	150	6"	60	2 3/8"	224197	1 U
CRNRE 200X60	200	8"	60	2 3/8"	224198	1 U
CRNRE 300X60	300	12"	60	2 3/8"	224199	1 U
CRNRE 400X60	400	16"	60	2 3/8"	224200	1 U
CRNRE 500X60	500	20"	60	2 3/8"	224201	1 U
CRNRE 600X60	600	24"	60	2 3/8"	224202	1 U

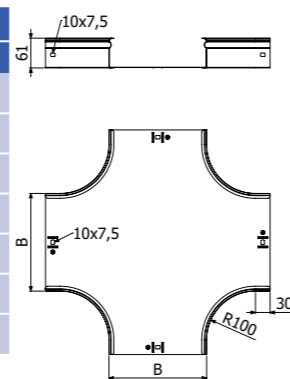

B = 100>300 2x JUNRE H60 (224217) + 4/100 x B1 (204356 EZ)  
B = 400>600 2x JUNRE H60 (224217) + 1x JUNRE-C (224252) + 6/100 x B1 (204356 EZ)

## CRNRE H75

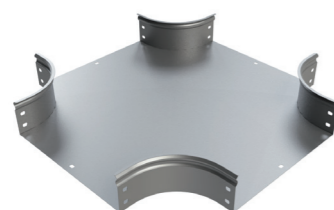

	B		H		PG	
	mm	inch	mm	inch	REF.	MOQ
CRNRE 100X75	100	4"	75	3"	224203	24 M
CRNRE 150X75	150	6"	75	3"	224204	24 M
CRNRE 200X75	200	8"	75	3"	224205	12 M
CRNRE 300X75	300	12"	75	3"	224206	12 M
CRNRE 400X75	400	16"	75	3"	224207	6 M
CRNRE 500X75	500	20"	75	3"	224208	6 M
CRNRE 600X75	600	24"	75	3"	224209	6 M

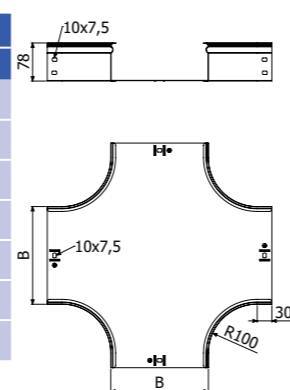

B = 100>300 2x JUNRE H75 (224218) + 8/100 x B1 (204356 EZ)  
B = 400>600 2x JUNRE H75 (224218) + 1x JUNRE-C (224252) + 10/100 x B1 (204356 EZ)

## TCRNRE

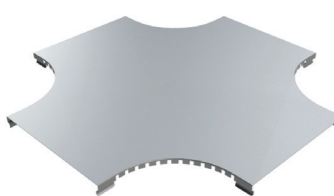

	B		PG	
	mm	inch	REF.	MOQ
TCRNRE 100	100	4"	224210	1 U
TCRNRE 150	150	6"	224211	1 U
TCRNRE 200	200	8"	224212	1 U
TCRNRE 300	300	12"	224213	1 U
TCRNRE 400	400	16"	224214	1 U
TCRNRE 500	500	20"	224215	1 U
TCRNRE 600	600	24"	224216	1 U

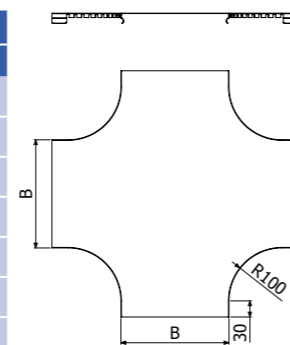

## ASNRE H60



	B		H		PG	
	mm	inch	mm	inch	REF.	MOQ
ASNRE 100X60	100	4"	60	2 3/8"	224223	1 U
ASNRE 150X60	150	6"	60	2 3/8"	224224	1 U
ASNRE 200X60	200	8"	60	2 3/8"	224225	1 U
ASNRE 300X60	300	12"	60	2 3/8"	224226	1 U
ASNRE 400X60	400	16"	60	2 3/8"	224227	1 U
ASNRE 500X60	500	20"	60	2 3/8"	224228	1 U
ASNRE 600X60	600	24"	60	2 3/8"	224229	1 U

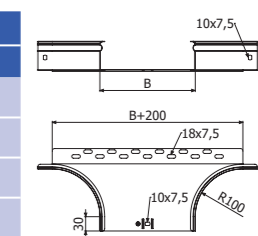

4/100 x B1 (204356 EZ)

## ASNRE H75

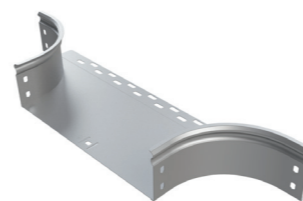

	B		H		PG	
	mm	inch	mm	inch	REF.	MOQ
ASNRE 100X75	100	4"	75	3"	224230	1 U
ASNRE 150X75	150	6"	75	3"	224231	1 U
ASNRE 200X75	200	8"	75	3"	224232	1 U
ASNRE 300X75	300	12"	75	3"	224233	1 U
ASNRE 400X75	400	16"	75	3"	224234	1 U
ASNRE 500X75	500	20"	75	3"	224235	1 U
ASNRE 600X75	600	24"	75	3"	224236	1 U

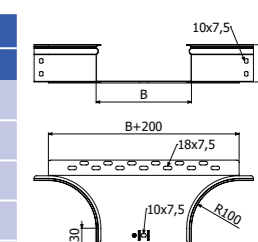

4/100 x B1 (204356 EZ)

## TASNRE



	B		PG	
	mm	inch	REF.	MOQ
TASNRE 100	100	4"	224237	1 U
TASNRE 150	150	6"	224238	1 U
TASNRE 200	200	8"	224239	1 U
TASNRE 300	300	12"	224240	1 U
TASNRE 400	400	16"	224241	1 U
TASNRE 500	500	20"	224242	1 U
TASNRE 600	600	24"	224243	1 U

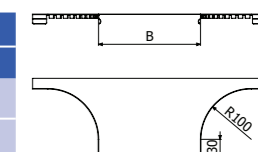

RENRE

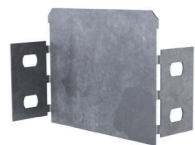

	B		PG	
	mm	inch	REF.	MOQ
RENRE-50X60	50	2"	224797	1 U
RENRE-100X60	100	4"	224798	1 U
RENRE-50X75	50	2"	224799	1 U
RENRE-100X75	100	4"	224800	1 U

4/100 x B1 - (204356)

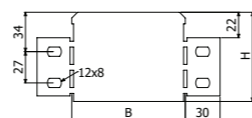

TFNRE

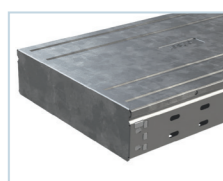
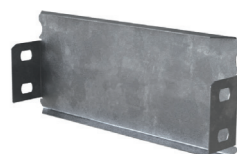

	B		H		PG	
	mm	inch	mm	inch	REF.	MOQ
TFNRE 150x75	150	6"	75	3"	224854	1 U
TFNRE 200x75	200	8"	75	3"	224855	1 U
TFNRE 300x75	300	12"	75	3"	224856	1 U
TFNRE 400x75	400	16"	75	3"	224857	1 U
TFNRE 500x75	500	20"	75	3"	224858	1 U
TFNRE 600x75	600	24"	75	3"	224859	1 U

4/100 x B1 - (204356)

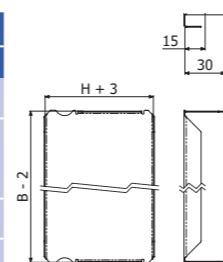

SUCP

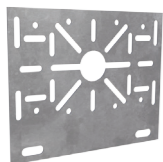

SUCP	B		PG	
	mm	inch	REF.	MOQ
	100	4"	214255	10 U

2/100 x B1 - (204356)

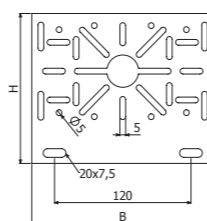

PS

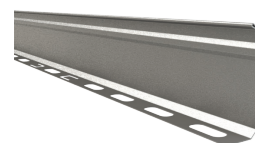

L = 3 m (10 ft)

	B		PG	
	mm	inch	REF.	MOQ
PS H60	100	2 1/3"	202066	30 M
PS H80	100	2 1/3"	203477	30 M

3 X 8 B1 (204356)

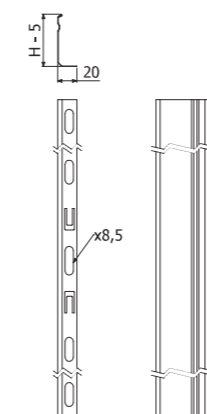

ACNRE H75

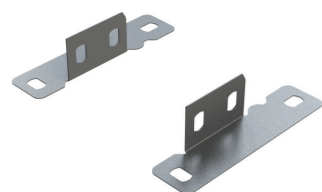

ACNRE H75	B		PG	
	mm	inch	REF.	MOQ
	75	3"	224860	1 U

4/100 x B1 - (204356)

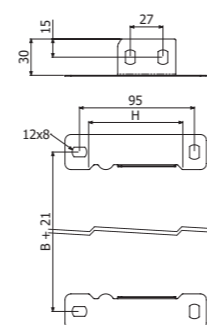
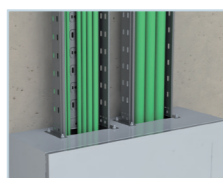

UNION JOINTS



JUNR2E 60/75



JUNR2E-A 60/75



JUNR2E-B 60/75



JUNRE-C



UCNRE

	B		PG	
	mm	inch	REF.	MOQ
JUNR2E H60	60	2 3/8"	224217	1 U
JUNR2E-A H60	60	2 3/8"	224219	1 U
JUNR2E-B H60	60	2 3/8"	224220	1 U
JUNR2E H75	75	3"	2/24218	1 U
JUNR2E-A H75	75	3"	2/24221	1 U
JUNR2E-B H75	75	3"	2/24222	1 U
JUNRE-C	75	3"	224861	1 U
UCNRE AL	-	-	224861	1 U

2-4/100 x B1 - (204356)

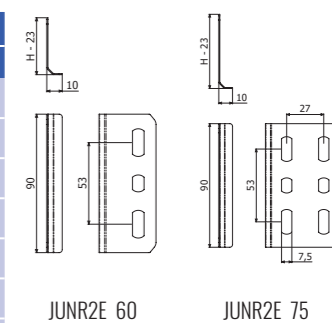
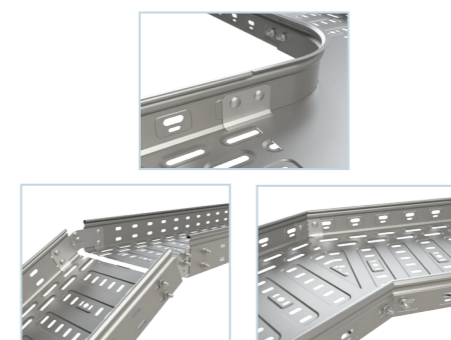

JUNR2E 60

JUNR2E 75

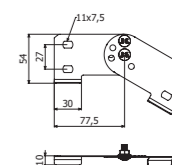

JUNR2E-A 60/75

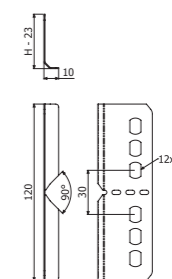

JUNR2E-B 60

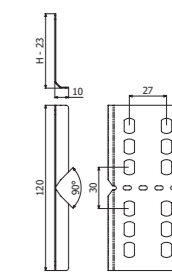

JUNR2E-B 75

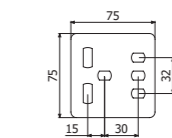

JUNRE-C

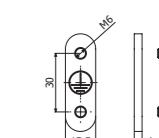

UCNRE

PBCH-20



PBCH-20 1MM	e	L	PVC	
	mm	m	REF.	MOQ
	≤1	20	2/10086	1 U

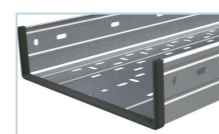

# BasorTRAY ERE50

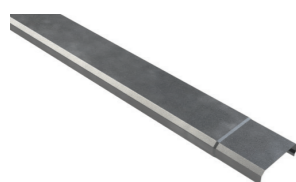
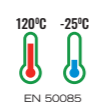
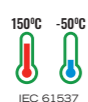
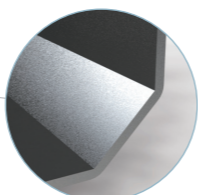
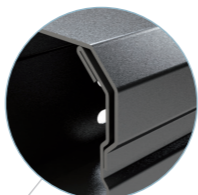
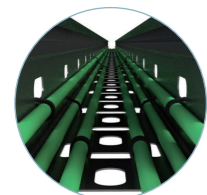

TERE 50



PTER 50X50



CPER 50X50



CCER 50X50



CXER 50X50

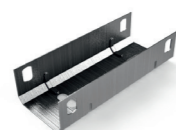

JUER 50X50



REER 50X50



B1

Filling Area			
B		H50 (2")	
mm	inch	cm <sup>2</sup>	in <sup>2</sup>
50	2	24	3,7

## BasorTRAY ERE

### ERE 50X50

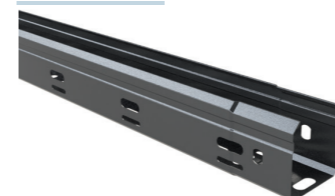

L = 3 m (10 ft)



### ERE-C 50X50

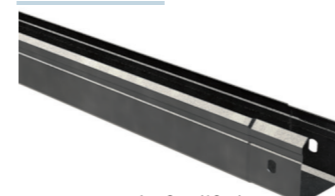

L = 3 m (10 ft)

	B		H		PG		HDG	
	mm	inch	mm	inch	REF.	MOQ	REF.	MOQ
ERE 50X50	50	2"	50	2"	210181	24 M	210182	24 M

3/100 x B1 (204356 - EZ // 206826 - HDG).

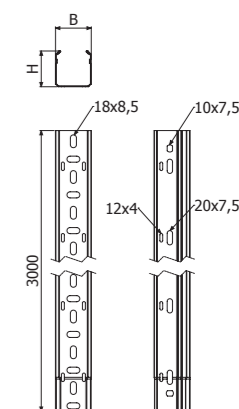

	B		H		PG		HDG	
	mm	inch	mm	inch	REF.	MOQ	REF.	MOQ
ERE-C 50X50	50	2"	50	2"	210183	24 M	210184	24 M

2/100 x B1 (204356 - EZ // 206826 - HDG).

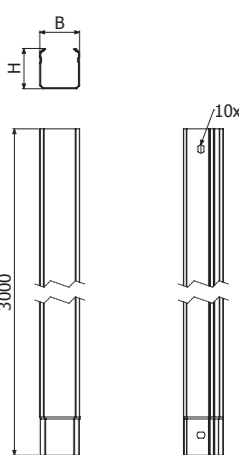

ERE 50

### TERE 50

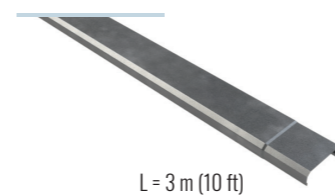

L = 3 m (10 ft)

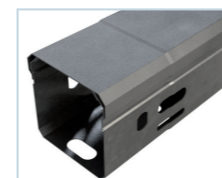

### PTER 50X50

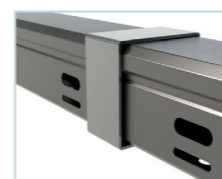

	B		PG		HDG	
	mm	inch	REF.	MOQ	REF.	MOQ
TERE 50	50	2"	210282	24 M	210283	3 M

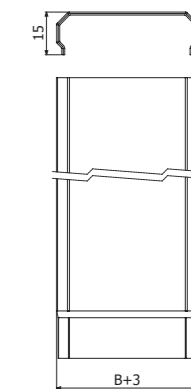

	B		H		i304	
	mm	inch	mm	inch	REF.	MOQ
PTER 50X50	50	2"	50	2"	208234	10 U

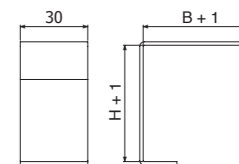

2 x PTER 50X50 => 1 x TERE 50

## BasorTRAY

ERE

### CPER 50X50



### CCER 50X50

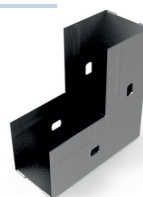

### CXER 50X50



### JUER 50X50

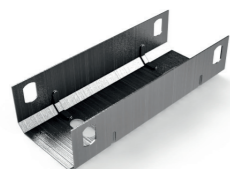

**3E**Basor  
CABLE TRAY SPECIALIST

	B		H		PG		HDG	
	mm	inch	mm	inch	REF.	MOQ	REF.	MOQ
CPER 50X50	50	2"	50	2"	203235	2 U	206950	2 U

1 x JUER 50X50 (202051 - PG // 202056 - HDG)

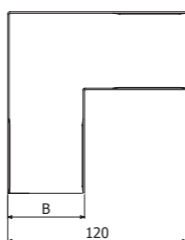
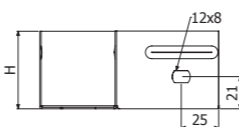

	B		H		PG		HDG	
	mm	inch	mm	inch	REF.	MOQ	REF.	MOQ
CCER 50X50	50	2"	50	2"	203236	2 U	206952	2 U

1 x JUER 50X50 (202051 - PG // 202056 - HDG)

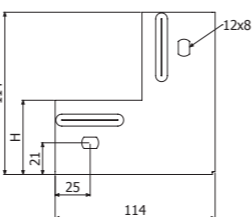

	B		H		PG		HDG	
	mm	inch	mm	inch	REF.	MOQ	REF.	MOQ
CXER 50X50	50	2"	50	2"	203238	2 U	206951	2 U

1 x JUER 50X50 (202051 - PG // 202056 - HDG)

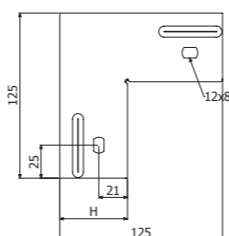

	B		PG		HDG	
	mm	inch	REF.	MOQ	REF.	MOQ
JUER 50X50	50	2"	202051	1 U	202056	1 U

4/100 x B1 (204356 - EZ // 206826 - HDG)

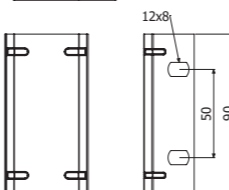
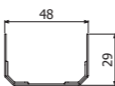

## BasorTRAY

ERE

### REER 50X50

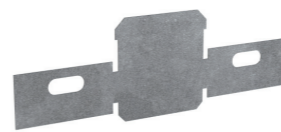

### B1



**3E**Basor  
CABLE TRAY SPECIALIST

	B		H		PG		HDG	
	mm	inch	mm	inch	REF.	MOQ	REF.	MOQ
REER 50X50	50	2"	50	2"	217267	10 U	217268	10 U

2/100 x B1 (204356 - EZ // 206826 - HDG)

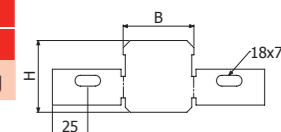

	L	Pap	EZ		HDG		i304	
			REF.	MOQ	REF.	MOQ	REF.	MOQ
B1-100	14	6	204356	1 U	206826	1 U	-	-
B1-100	20	6	-	-	-	-	204925	1 U

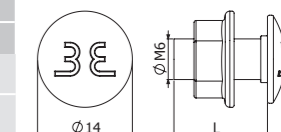

# BasorTRAY ERE

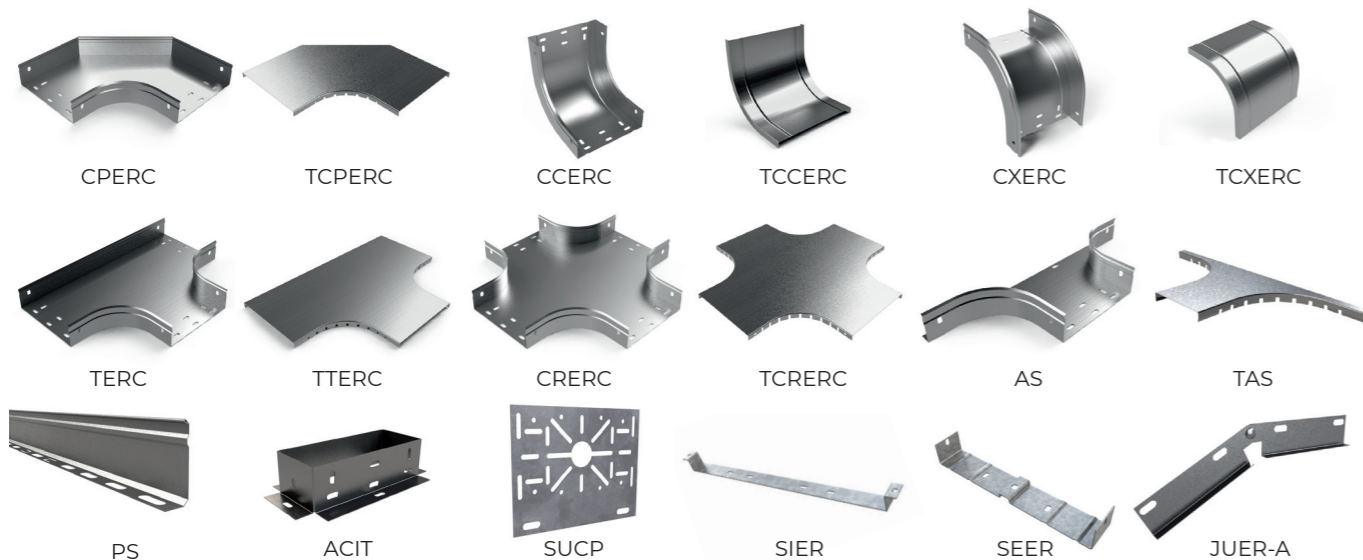
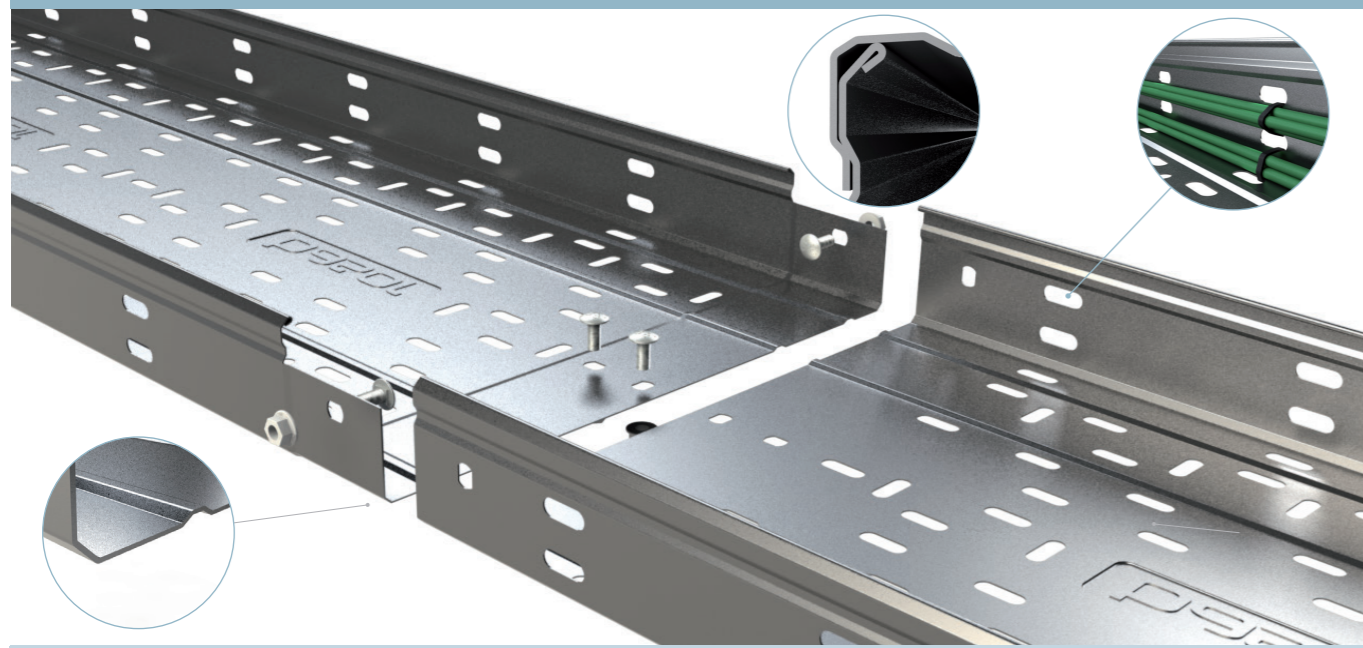

Filling Area							
B		H35 (1 3/8")		H60 (2 3/8")		H100 (4")	
mm	inch	cm <sup>2</sup>	in <sup>2</sup>	cm <sup>2</sup>	in <sup>2</sup>	cm <sup>2</sup>	in <sup>2</sup>
100	4"	34	5,2	59	9,1	98	15,1
150	6"	51	7,9	89	13,7	148	22,9
200	8"	69	10,6	119	18,4	198	30,6
300	12"	103	15,9	178	27,5	298	46,1
400	16"	-	-	238	36,8	397	61,5
500	20"	-	-	298	46,1	497	77,0
600	24"	-	-	358	55,4	597	92,5

## BasorTRAY ERE

### ERE H35



L = 3 m (10 ft)

	B		H		PG		HDG		i304 i316
	mm	inch	mm	inch	REF.	MOQ	REF.	MOQ	
ERE 100X35	100	4"	35	1 3/8"	201192	24 M	201222	3 M	
ERE 150X35	150	6"	35	1 3/8"	201193	24 M	201223	3 M	
ERE 200X35	200	8"	35	1 3/8"	201194	18 M	201224	3 M	
ERE 300X35	300	12"	35	1 3/8"	201195	12 M	201225	3 M	

4/100 x B1 - (204356-EZ // 206826-HDG // 204925-i304)

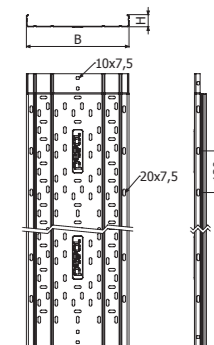

### ERE-C H35



L = 3 m (10 ft)

	B		H		PG		i304 i316
	mm	inch	mm	inch	REF.	MOQ	
ERE-C 100X35	100	4"	35	1 3/8"	201252	24 M	
ERE-C 150X35	150	6"	35	1 3/8"	201253	24 M	
ERE-C 200X35	200	8"	35	1 3/8"	201254	18 M	
ERE-C 300X35	300	12"	35	1 3/8"	201255	12 M	

4/100 x B1 - (204356-EZ // 206826-HDG // 204925-i304)

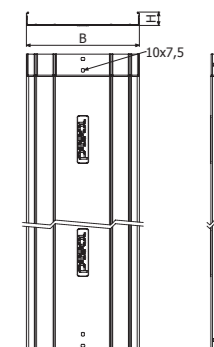

### ERE H60

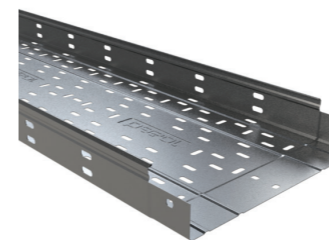

L = 3 m (10 ft)

	B		H		PG		HDG		i304		i316
	mm	inch	mm	inch	REF.	MOQ	REF.	MOQ	REF.	MOQ	
ERE 100X60	100	4"	60	2 3/8"	201197	24 M	201227	3 M	204795	12 M	
ERE 150X60	150	6"	60	2 3/8"	201198	12 M	201228	3 M	204319	12 M	
ERE 200X60	200	8"	60	2 3/8"	201199	12 M	201229	3 M	204688	6 M	
ERE 300X60	300	12"	60	2 3/8"	201201	6 M	201231	3 M	204317	6 M	
ERE 400X60	400	16"	60	2 3/8"	201202	6 M	201232	3 M	204933	6 M	
ERE 500X60	500	20"	60	2 3/8"	201203	6 M	201233	3 M	-	-	
ERE 600X60	600	24"	60	2 3/8"	201204	6 M	201234	3 M	204373	6 M	

4/100 x B1 - (204356-EZ // 206826-HDG // 204925-i304)

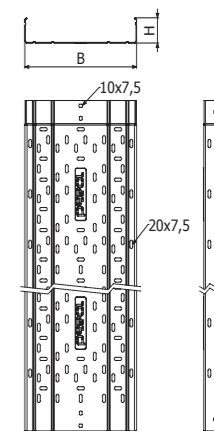

### ERE-C H60



L = 3 m (10 ft)

	B		H		PG		HDG		i304		i316
	mm	inch	mm	inch	REF.	MOQ	REF.	MOQ	REF.	MOQ	
ERE-C 100X60	100	4"	60	2 3/8"	201257	24 M	201287	3 M	204907	12 M	
ERE-C 150X60	150	6"	60	2 3/8"	201258	12 M	201288	3 M	205028	12 M	
ERE-C 200X60	200	8"	60	2 3/8"	201259	12 M	201289	3 M	205029	6 M	
ERE-C 300X60	300	12"	60	2 3/8"	201261	6 M	201291	3 M	204306	6 M	
ERE-C 400X60	400	16"	60	2 3/8"	201262	6 M	201292	3 M	205196	6 M	
ERE-C 500X60	500	20"	60	2 3/8"	201263	6 M	201293	3 M	-	-	
ERE-C 600X60	600	24"	60	2 3/8"	201264	6 M	201294	3 M	205197	6 M	

4/100 x B1 - (204356-EZ // 206826-HDG // 204925-i304)

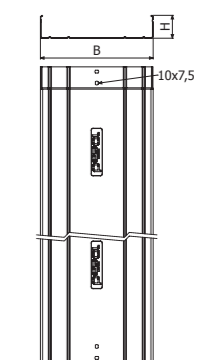



**BasorTRAY**  
ERE



**ERE H80**



L = 3 m (10 ft)

	B		H		PG		HDG	
	mm	inch	mm	inch	REF.	MOQ	REF.	MOQ
ERE 100X80	100	4"	80	3 1/7"	201205	12 M	201235	3 M
ERE 150X80	150	6"	80	3 1/7"	201206	12 M	201236	3 M
ERE 200X80	200	8"	80	3 1/7"	201207	12 M	201237	3 M
ERE 300X80	300	12"	80	3 1/7"	201209	6 M	201239	3 M
ERE 400X80	400	16"	80	3 1/7"	201210	6 M	201240	3 M
ERE 500X80	500	20"	80	3 1/7"	201211	6 M	201241	3 M
ERE 600X80	600	24"	80	3 1/7"	201212	6 M	201242	3 M

4/100 x B1 - (204356-EZ // 206826-HDG)

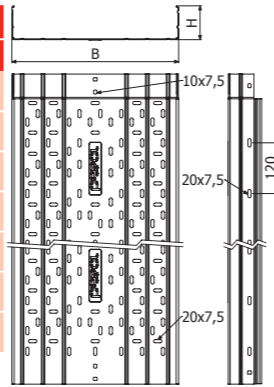

**ERE-C H80**

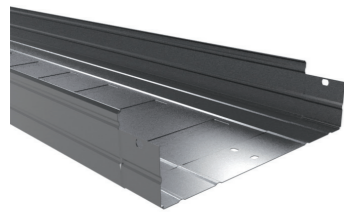

L = 3 m (10 ft)

	B		H		PG		HDG	
	mm	inch	mm	inch	REF.	MOQ	REF.	MOQ
ERE-C 100X80	100	4"	80	3 1/7"	201265	12 M	201295	3 M
ERE-C 150X80	150	6"	80	3 1/7"	201266	12 M	201296	3 M
ERE-C 200X80	200	8"	80	3 1/7"	201267	12 M	201297	3 M
ERE-C 300X80	300	12"	80	3 1/7"	201269	6 M	201299	3 M
ERE-C 400X80	400	16"	80	3 1/7"	201270	6 M	201300	3 M
ERE-C 500X80	500	20"	80	3 1/7"	201271	6 M	201301	3 M
ERE-C 600X80	600	24"	80	3 1/7"	201272	6 M	201302	3 M

4/100 x B1 - (204356-EZ // 206826-HDG)

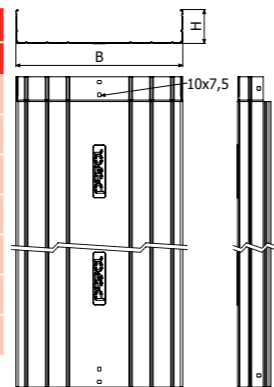

**ERE H100**

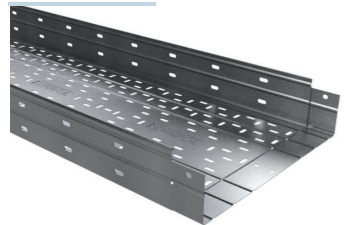

L = 3 m (10 ft)

	B		H		PG		HDG		i304 i316
	mm	inch	mm	inch	REF.	MOQ	REF.	MOQ	
ERE 100X100	100	4"	100	4"	201213	12 M	201243	3 M	
ERE 150X100	150	6"	100	4"	201214	12 M	201244	3 M	
ERE 200X100	200	8"	100	4"	201215	12 M	201245	3 M	
ERE 300X100	300	12"	100	4"	201217	6 M	201247	3 M	
ERE 400X100	400	16"	100	4"	201218	6 M	201248	3 M	
ERE 500X100	500	20"	100	4"	201219	6 M	201249	3 M	
ERE 600X100	600	24"	100	4"	201220	6 M	201250	3 M	

4/100 x B1 - (204356-EZ // 206826-HDG // 204925-i304)

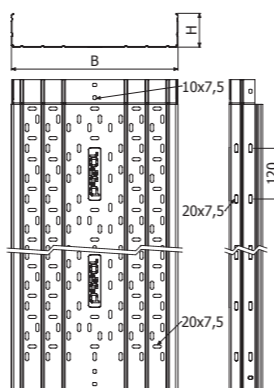

**ERE-C H100**

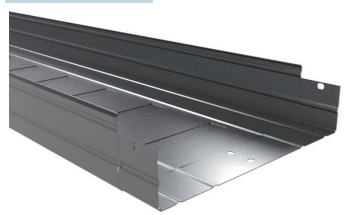

L = 3 m (10 ft)

	B		H		PG		HDG		i304 i316
	mm	inch	mm	inch	REF.	MOQ	REF.	MOQ	
ERE-C 100X100	100	4"	100	4"	201273	12 M	201303	3 M	
ERE-C 150X100	150	6"	100	4"	201274	12 M	201304	3 M	
ERE-C 200X100	200	8"	100	4"	201275	12 M	201305	3 M	
ERE-C 300X100	300	12"	100	4"	201277	6 M	201307	3 M	
ERE-C 400X100	400	16"	100	4"	201278	6 M	201308	3 M	
ERE-C 500X100	500	20"	100	4"	201279	6 M	201309	3 M	
ERE-C 600X100	600	24"	100	4"	201280	6 M	201310	3 M	

4/100 x B1 - (204356-EZ // 206826-HDG // 204925-i304)

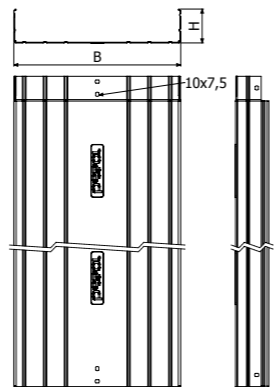

**BasorTRAY**  
ERE



**TERE**

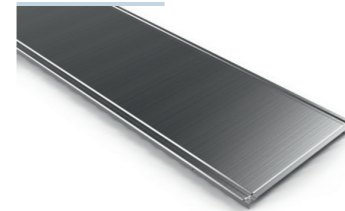

L = 3 m (10 ft)  
100/150/200/300

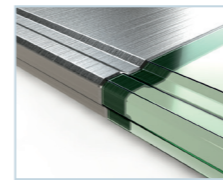

	B		PG		HDG		i304	
	mm	inch	REF.	MOQ	REF.	MOQ	REF.	MOQ
TERE 100	100	4"	201312	24 M	201321	3 M	204560	12 M
TERE 150	150	6"	201313	24 M	201322	3 M	205123	12 M
TERE 200	200	8"	201314	24 M	201323	3 M	204561	12 M
TERE 300	300	12"	201316	18 M	201325	3 M	204716	12 M
TERE 400 2M	400	16"	201317	12 M	201326	2 M	-	-
TERE 500 2M	500	20"	201318	8 M	201327	2 M	-	-
TERE 600 2M	600	24"	201319	8 M	201328	2 M	-	-
TERE 400 3M	400	16"	-	-	-	-	204931	6 M
TERE 500 3M	500	20"	-	-	-	-	204562	6 M
TERE 600 3M	600	24"	-	-	-	-	205357	6 M

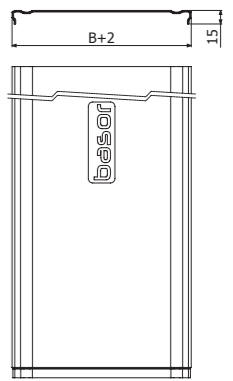

**PTERE**

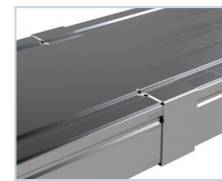
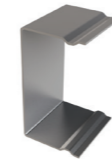

	H		i304	
	mm	inch	REF.	MOQ
PTERE 35	35	1 3/8"	207059	20 U
PTERE 60	60	2 3/8"	207060	24 U
PTERE 80	80	3 1/8"	207061	20 U
PTERE 100	100	4"	207062	20 U



4 x PTERE => 1 x TERE

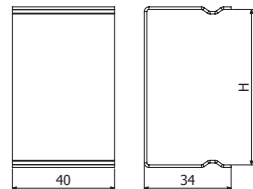

# BasorTRAY MRE

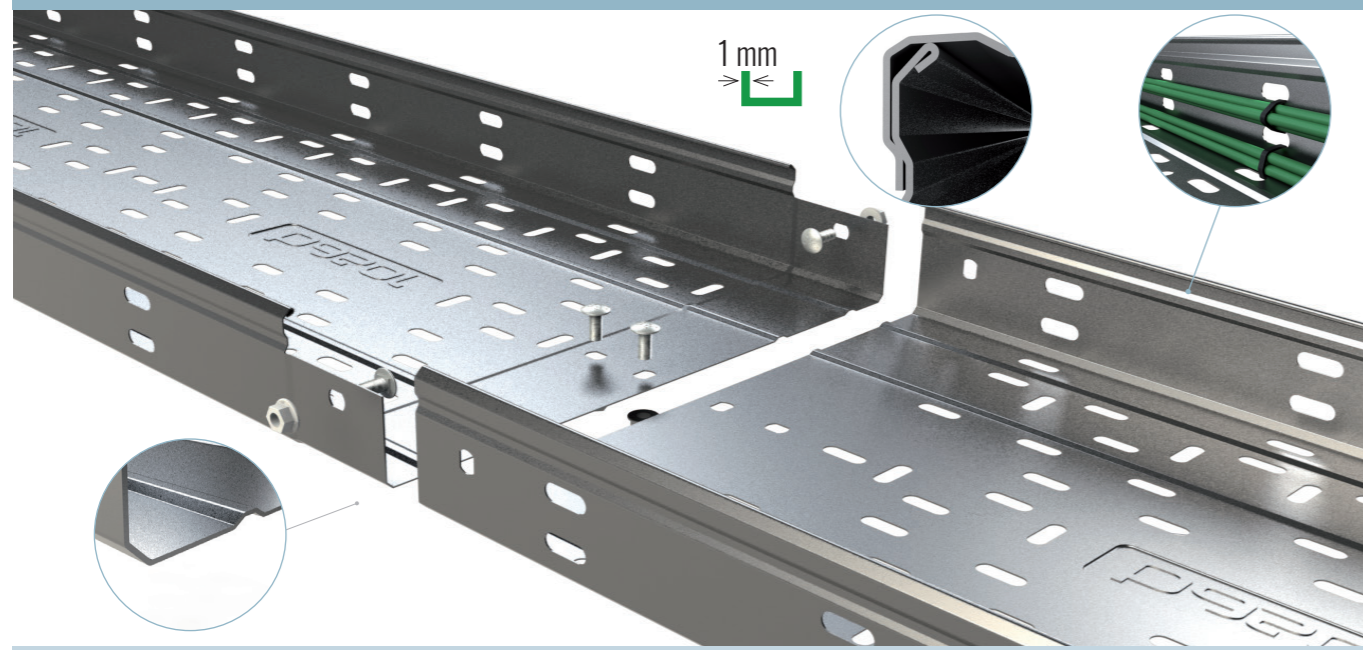

L > 100m IEC 61537 EN 50085  
 NO + MO/A1 IEC 61537 EN 50085 UNE 201010  
 150°C -50°C IEC 61537  
 120°C -25°C EN 50085  
 IEC 61537  
 20J IEC 61537  
 OK  
 IP44 IEC 60529  
 IP23 IEC 60529  
 IK10 IEC 50102  
 IK07 IEC 50102

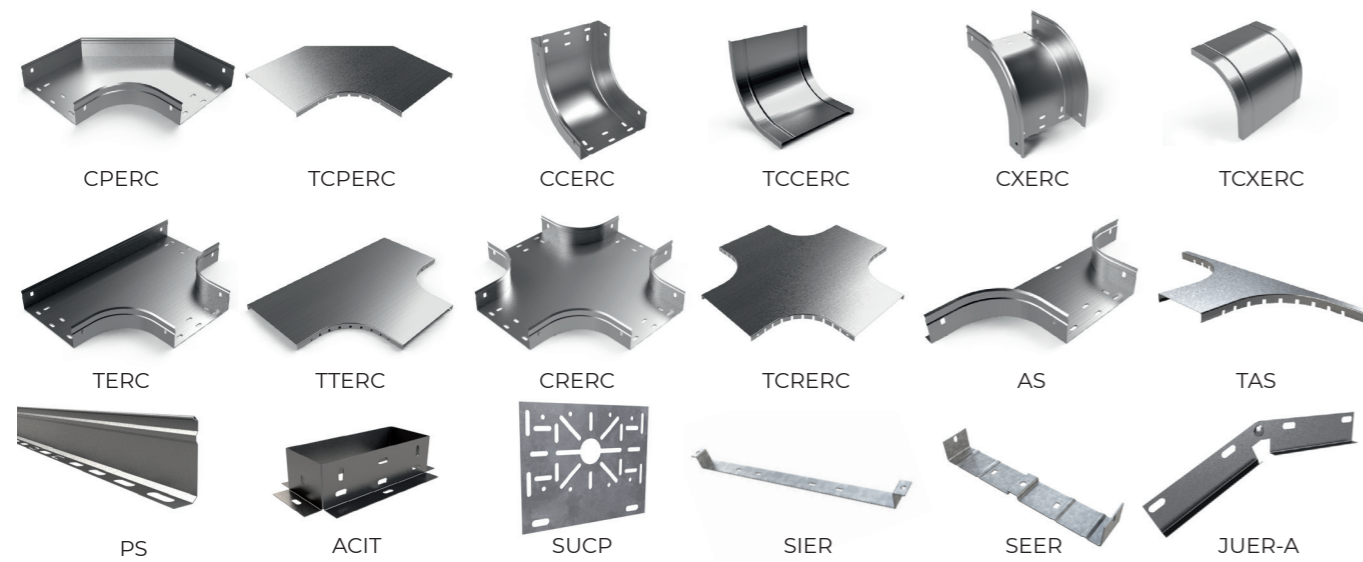

Filling Area					
B		H60 (2 3/8")		H100 (4")	
mm	inch	cm <sup>2</sup>	in <sup>2</sup>	cm <sup>2</sup>	in <sup>2</sup>
100	4"	59	9,1	98	15,1
150	6"	89	13,7	148	22,9
200	8"	119	18,4	198	30,6
300	12"	178	27,5	298	46,1
400	16"	238	36,8	397	61,5
500	20"	298	46,1	497	77,0
600	24"	358	55,4	597	92,5

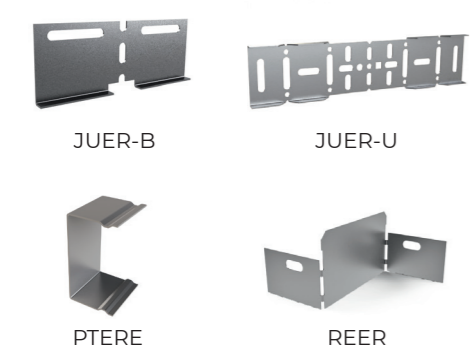

## BasorTRAY MRE

### MRE H60

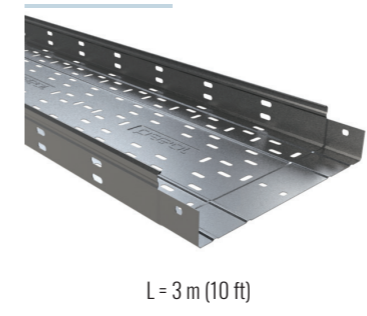

	B		H		e	PG		HDG		i304 i316
	mm	inch	mm	inch		REF.	MOQ	REF.	MOQ	
MRE 100X60	100	4"	60	2 3/8"	1	207273	3 M	207517	3 M	
MRE 150X60	150	6"	60	2 3/8"	1	207274	3 M	207518	3 M	
MRE 200X60	200	8"	60	2 3/8"	1	207275	3 M	207519	3 M	
MRE 300X60	300	12"	60	2 3/8"	1	207276	3 M	207520	3 M	
MRE 400X60	400	16"	60	2 3/8"	1	207277	3 M	207521	3 M	
MRE 500X60	500	20"	60	2 3/8"	1	207278	3 M	207522	3 M	
MRE 600X60	600	24"	60	2 3/8"	1	207279	3 M	207523	3 M	

4/100 x B1 - (204356-EZ // 206826-HDG // 204925-i304)

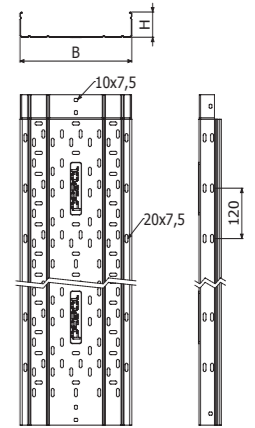

### MRE H100

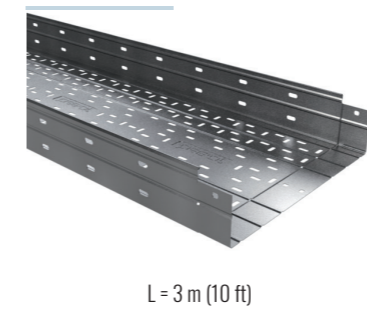

	B		H		e	PG		HDG		i304 i316
	mm	inch	mm	inch		REF.	MOQ	REF.	MOQ	
MRE 150X100	150	6"	100	4"	1	207409	3 M	207524	3 M	
MRE 200X100	200	8"	100	4"	1	207410	3 M	207525	3 M	
MRE 300X100	300	12"	100	4"	1	207411	3 M	207526	3 M	
MRE 400X100	400	16"	100	4"	1	207412	3 M	207527	3 M	
MRE 500X100	500	20"	100	4"	1	207413	3 M	207528	3 M	
MRE 600X100	600	24"	100	4"	1	207414	3 M	207529	3 M	

4/100 x B1 - (204356-EZ // 206826-HDG // 204925-i304)

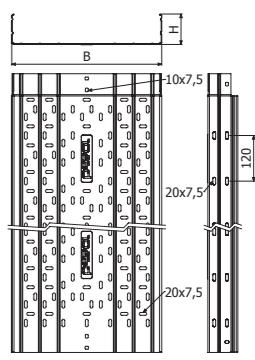

## TERE

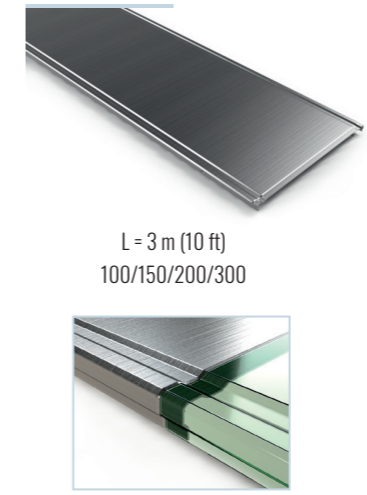

	B		PG		HDG		i304	
	mm	inch	REF.	MOQ	REF.	MOQ	REF.	MOQ
TERE 100	100	4"	201312	24 M	201321	3 M	204560	12 M
TERE 150	150	6"	201313	24 M	201322	3 M	205123	12 M
TERE 200	200	8"	201314	24 M	201323	3 M	204561	12 M
TERE 300	300	12"	201316	18 M	201325	3 M	204716	12 M
TERE 400 2M	400	16"	201317	12 M	201326	2 M	-	-
TERE 500 2M	500	20"	201318	8 M	201327	2 M	-	-
TERE 600 2M	600	24"	201319	8 M	201328	2 M	-	-
TERE 400 3M	400	16"	-	-	-	-	204931	6 M
TERE 500 3M	500	20"	-	-	-	-	204562	6 M
TERE 600 3M	600	24"	-	-	-	-	205357	6 M

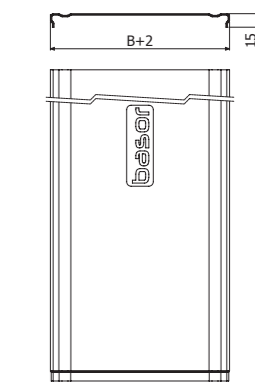

# BasorTRAY FRE

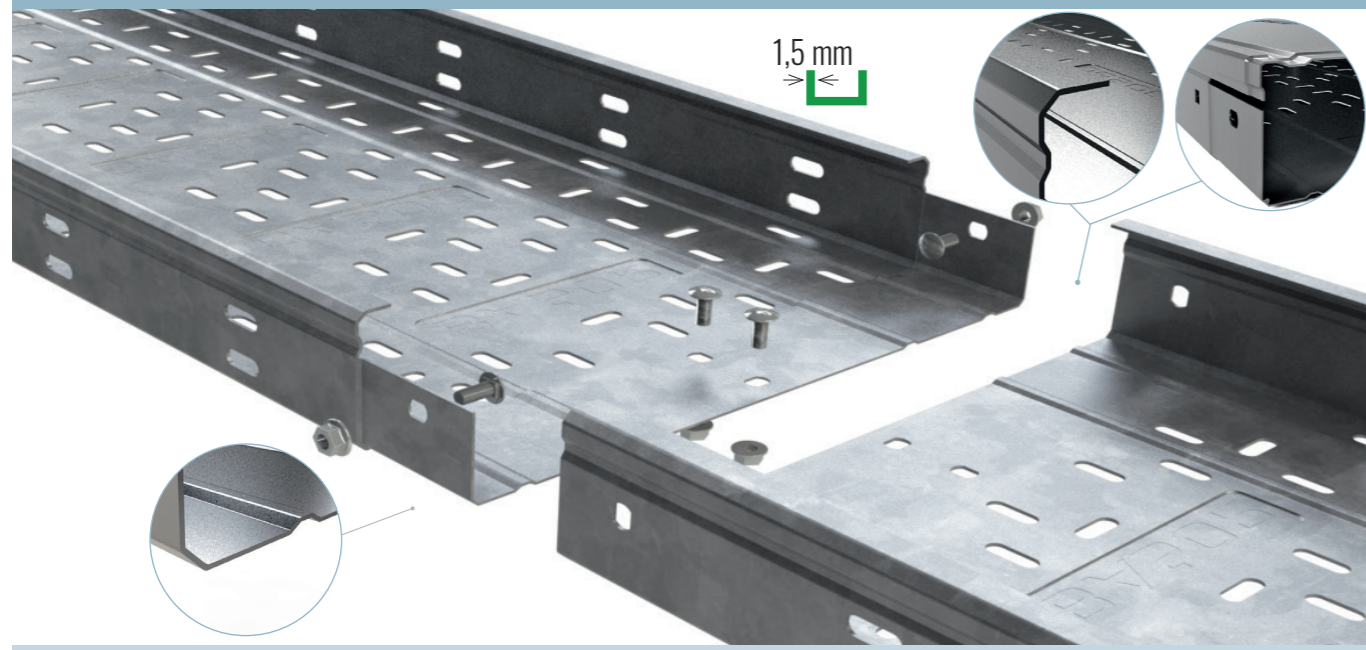

L > 100m IEC 61537 EN 50085  
 NO + MO/AI IEC 61537 EN 50085 UNE 201010  
 150°C -50°C IEC 61537  
 120°C -25°C EN 50085  
 IEC 61537  
 20J IEC 61537  
 OK  
 IP44 IP23 IEC 60529  
 IK10 IK07 IEC 50102

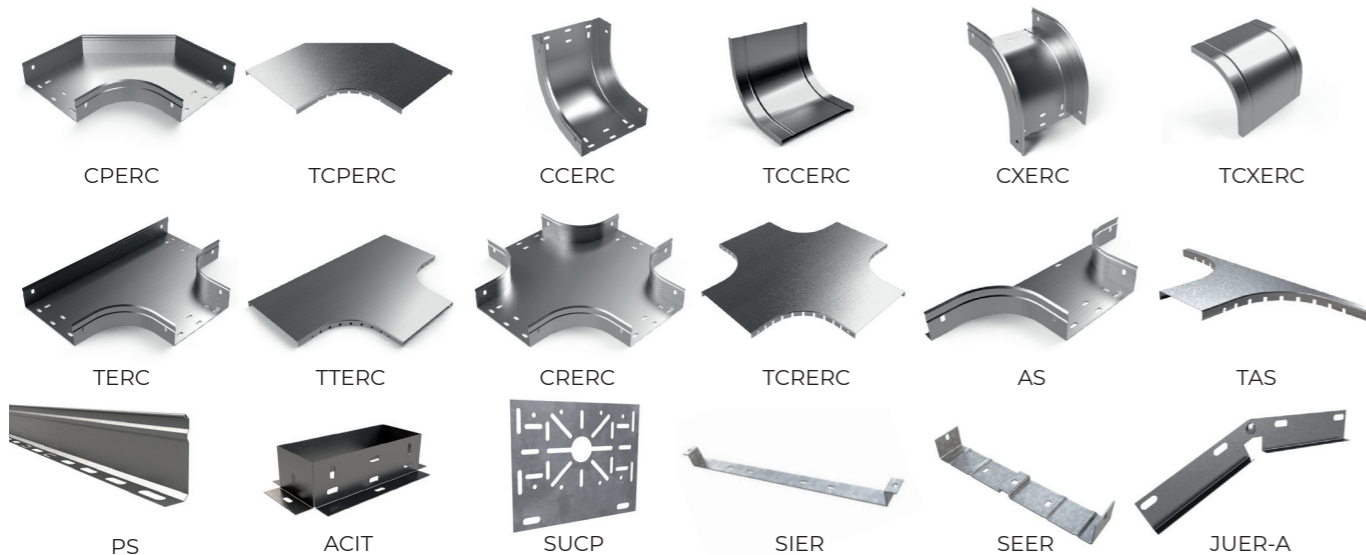

Filling Area							
B		H35 (1 3/8")		H60 (2 3/8")		H100 (4")	
mm	inch	cm <sup>2</sup>	in <sup>2</sup>	cm <sup>2</sup>	in <sup>2</sup>	cm <sup>2</sup>	in <sup>2</sup>
100	4"	34	5.2	59	9.1	98	15.1
150	6"	51	7.9	89	13.7	148	22.9
200	8"	69	10.6	119	18.4	198	30.6
300	12"	103	15.9	178	27.5	298	46.1
400	16"	-	-	238	36.8	397	61.5
500	20"	-	-	298	46.1	497	77.0
600	24"	-	-	358	55.4	597	92.5

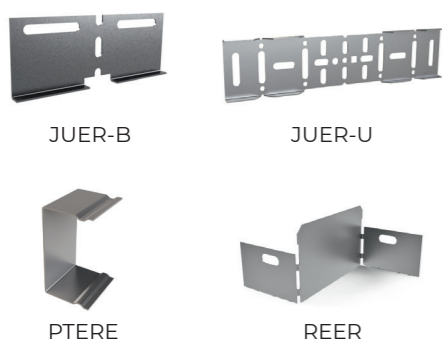

## BasorTRAY FRE

### FRE H35

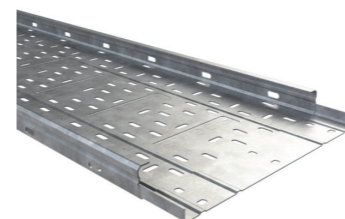

L = 3 m (10 ft)

	B		H		e	PG	
	mm	inch	mm	inch		REF.	MOQ
FRE 100X35	100	4"	35	1 3/8"	1,5	200051	3 M
FRE 150X35	150	6"	35	1 3/8"	1,5	200052	3 M
FRE 200X35	200	8"	35	1 3/8"	1,5	200053	3 M
FRE 300X35	300	12"	35	1 3/8"	1,5	200054	3 M

4/100 x B1 - (204356-EZ // 206826-HDG // 204925-i304)

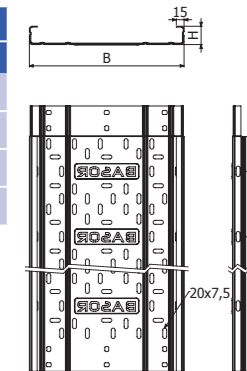

### FRE H60

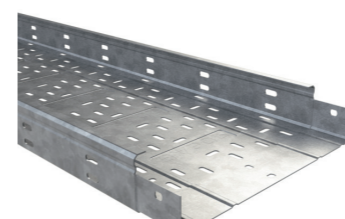

L = 3 m (10 ft)

	B		H		e	PG		HDG	
	mm	inch	mm	inch		mm	REF.	MOQ	REF.
FRE 100X60	100	4"	60	2 3/8"	1,5	200006	3 M	200056	3 M
FRE 150X60	150	6"	60	2 3/8"	1,5	200007	3 M	200057	3 M
FRE 200X60	200	8"	60	2 3/8"	1,5	200008	3 M	200058	3 M
FRE 300X60	300	12"	60	2 3/8"	1,5	200009	3 M	200059	3 M
FRE 400X60	400	16"	60	2 3/8"	1,5	200010	3 M	200060	3 M
FRE 500X60	500	20"	60	2 3/8"	1,5	200011	3 M	200061	3 M
FRE 600X60	600	24"	60	2 3/8"	1,5	200012	3 M	200062	3 M

4/100 x B1 - (204356-EZ // 206826-HDG // 204925-i304)

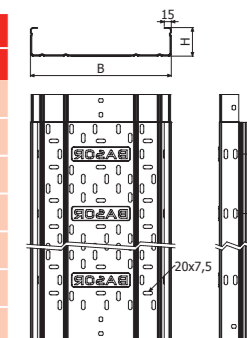

### FRE H100

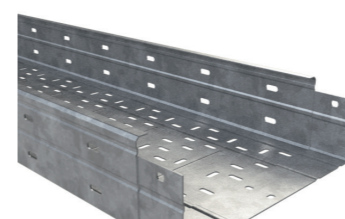

L = 3 m (10 ft)

	B		H		e	PG		HDG	
	mm	inch	mm	inch		mm	REF.	MOQ	REF.
FRE 100X100	100	4"	100	4"	1,5	200020	6 M	204556	3 M
FRE 150X100	150	6"	100	4"	1,5	200021	6 M	200070	3 M
FRE 200X100	200	8"	100	4"	1,5	200022	6 M	200071	3 M
FRE 300X100	300	12"	100	4"	1,5	200023	6 M	200072	3 M
FRE 400X100	400	16"	100	4"	1,5	200024	6 M	200073	3 M
FRE 500X100	500	20"	100	4"	1,5	200025	6 M	200074	3 M
FRE 600X100	600	24"	100	4"	1,5	200025	6 M	200075	3 M

4/100 x B1 - (204356-EZ // 206826-HDG // 204925-i304)

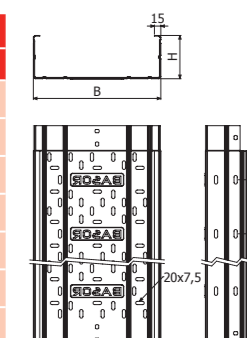

### TERE

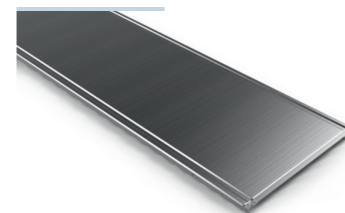

L = 3 m (10 ft)  
100/150/200/300

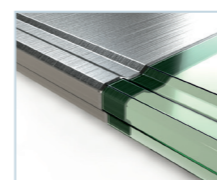

	B		PG		HDG		i304	
	mm	inch	REF.	MOQ	REF.	MOQ	REF.	MOQ
TERE 100	100	4"	201312	24 M	201321	3 M	204560	12 M
TERE 150	150	6"	201313	24 M	201322	3 M	205123	12 M
TERE 200	200	8"	201314	24 M	201323	3 M	204561	12 M
TERE 300	300	12"	201316	18 M	201325	3 M	204716	12 M
TERE 400 2M	400	16"	201317	12 M	201326	2 M	-	-
TERE 500 2M	500	20"	201318	8 M	201327	2 M	-	-
TERE 600 2M	600	24"	201319	8 M	201328	2 M	-	-
TERE 400 3M	400	16"	-	-	-	-	204931	6 M
TERE 500 3M	500	20"	-	-	-	-	204562	6 M
TERE 600 3M	600	24"	-	-	-	-	205357	6 M

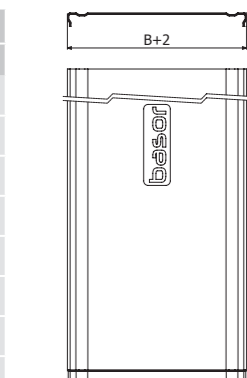

**BasorTRAY**  
ERE-MRE-FRE



**TFRE**

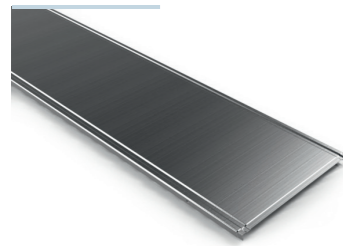

L = 3 m (10 ft)  
400/500/600 - L = 2 m (6,56 ft)

	B		e	HDG	
	mm	inch		REF.	MOQ
TFRE 100	100	4"	1,5	206421	3 M
TFRE 150	150	6"	1,5	206422	3 M
TFRE 200	200	8"	1,5	206423	3 M
TFRE 300	300	12"	1,5	206424	3 M
TFRE 400 2M	400	16"	1,5	271849	2 M
TFRE 500 2M	500	20"	1,5	271850	2 M
TFRE 600 2M	600	24"	1,5	211232	2 M

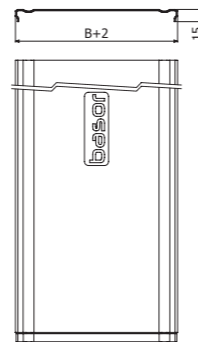

**PTERE**

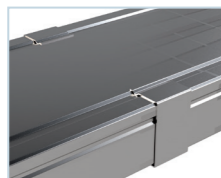

	H		i304		i316
	mm	inch	REF.	MOQ	
PTERE 35	35	1 3/8"	207059	1 U	
PTERE 60	60	2 3/8"	207060	1 U	
PTERE 80	80	3 1/7"	207061	1 U	
PTERE 100	100	4"	207062	1 U	



4 x PTERE => 1 x TERE

**BasorTRAY**  
ERE-MRE-FRE



**CPERC**

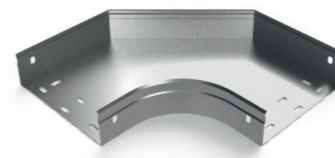

	B		H		PG		HDG		i304		i316
	mm	inch	mm	inch	REF.	MOQ	REF.	MOQ	REF.	MOQ	
CPERC 100x35	100	4"	35	1 3/8"	201337	2 U	201368	2 U			
CPERC 150x35	150	6"	35	1 3/8"	201338	2 U	201369	2 U			
CPERC 200x35	200	8"	35	1 3/8"	201339	2 U	201370	2 U			
CPERC 300x35	300	12"	35	1 3/8"	201340	2 U	201371	2 U			
CPERC 100x60	100	4"	60	2 3/8"	201344	2 U	201375	2 U	204777	1 U	
CPERC 150x60	150	6"	60	2 3/8"	201345	2 U	201376	2 U	205317	1 U	
CPERC 200x60	200	8"	60	2 3/8"	201346	2 U	201377	2 U	204778	1 U	
CPERC 300x60	300	12"	60	2 3/8"	201348	2 U	201379	2 U	206180	1 U	
CPERC 400x60	400	16"	60	2 3/8"	201349	1 U	201380	2 U	207390	1 U	
CPERC 500x60	500	20"	60	2 3/8"	201350	1 U	201381	2 U	-	-	
CPERC 600x60	600	24"	60	2 3/8"	201351	1 U	201382	2 U	207391	1 U	
CPERC 100x80	100	4"	80	3 1/7"	201352	2 U	201383	2 U	-	-	
CPERC 150x80	150	6"	80	3 1/7"	201353	2 U	201384	2 U	-	-	
CPERC 200x80	200	8"	80	3 1/7"	201354	2 U	201385	2 U	-	-	
CPERC 300x80	300	12"	80	3 1/7"	201356	2 U	201387	2 U	-	-	
CPERC 400x80	400	16"	80	3 1/7"	201357	1 U	201388	2 U	-	-	
CPERC 500x80	500	20"	80	3 1/7"	201358	1 U	201389	2 U	-	-	
CPERC 600x80	600	24"	80	3 1/7"	201359	1 U	201390	2 U	-	-	
CPERC 100x100	100	4"	100	4"	201360	2 U	201391	2 U			
CPERC 150x100	150	6"	100	4"	201361	2 U	201392	2 U			
CPERC 200x100	200	8"	100	4"	201362	2 U	201393	2 U			
CPERC 300x100	300	12"	100	4"	201364	2 U	201395	2 U			
CPERC 400x100	400	16"	100	4"	201365	1 U	201396	2 U			
CPERC 500x100	500	20"	100	4"	201366	1 U	201397	2 U			
CPERC 600x100	600	24"	100	4"	201367	1 U	201398	2 U			

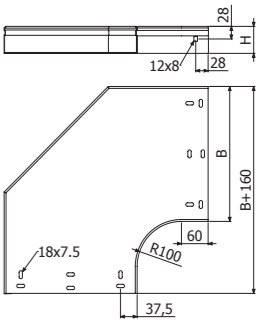

2 x JUER + 4/100 x B1 (204356 - EZ // 206826 - HDG // 204925 - i304)

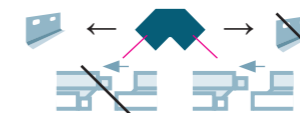
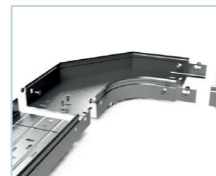

**TCPERC**

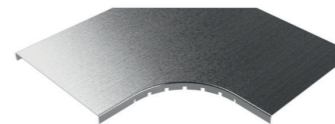

	B		PG		HDG		i304	
	mm	inch	REF.	MOQ	REF.	MOQ	REF.	MOQ
TCPERC 100	100	4"	201430	1 U	201437	1 U	203560	1 U
TCPERC 150	150	6"	201431	1 U	201438	1 U	203561	1 U
TCPERC 200	200	8"	201432	1 U	201439	1 U	203562	1 U
TCPERC 300	300	12"	201433	1 U	201440	1 U	203563	1 U
TCPERC 400	400	16"	201434	1 U	201441	1 U	204752	1 U
TCPERC 500	500	20"	201435	1 U	201442	1 U	-	-
TCPERC 600	600	24"	201436	1 U	201443	1 U	204753	1 U

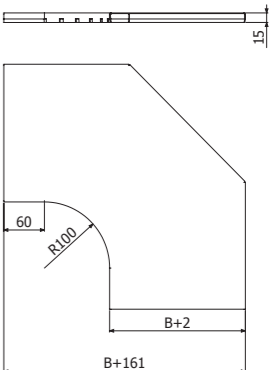



**TERC**

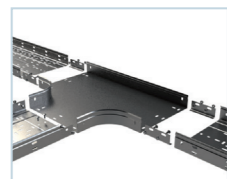
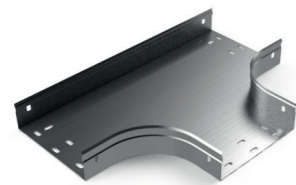

	B		H		PG		HDG	
	mm	inch	mm	inch	REF.	MOQ	REF.	MOQ
TERC 100x35	100	4"	35	1 3/8"	201751	1 U	201782	1 U
TERC 150x35	150	6"	35	1 3/8"	201752	1 U	201783	1 U
TERC 200x35	200	8"	35	1 3/8"	201753	1 U	201784	1 U
TERC 300x35	300	12"	35	1 3/8"	201754	1 U	201785	1 U
TERC 100x60	100	4"	60	2 3/8"	201758	1 U	201789	1 U
TERC 150x60	150	6"	60	2 3/8"	201759	1 U	201790	1 U
TERC 200x60	200	8"	60	2 3/8"	201760	1 U	201791	1 U
TERC 300x60	300	12"	60	2 3/8"	201762	1 U	201793	1 U
TERC 400x60	400	16"	60	2 3/8"	201763	1 U	201794	1 U
TERC 500x60	500	20"	60	2 3/8"	201764	1 U	201795	1 U
TERC 600x60	600	24"	60	2 3/8"	201765	1 U	201796	1 U
TERC 100x80	100	4"	80	3 1/7"	201766	1 U	201797	1 U
TERC 150x80	150	6"	80	3 1/7"	201767	1 U	201798	1 U
TERC 200x80	200	8"	80	3 1/7"	201768	1 U	201799	1 U
TERC 300x80	300	12"	80	3 1/7"	201770	1 U	201801	1 U
TERC 400x80	400	16"	80	3 1/7"	201771	1 U	201802	1 U
TERC 500x80	500	20"	80	3 1/7"	201772	1 U	201803	1 U
TERC 600x80	600	24"	80	3 1/7"	201773	1 U	201804	1 U
TERC 100x100	100	4"	100	4"	201774	1 U	201805	1 U
TERC 150x100	150	6"	100	4"	201775	1 U	201806	1 U
TERC 200x100	200	8"	100	4"	201776	1 U	201807	1 U
TERC 300x100	300	12"	100	4"	201778	1 U	201809	1 U
TERC 400x100	400	16"	100	4"	201779	1 U	201810	1 U
TERC 500x100	500	20"	100	4"	201780	1 U	201811	1 U
TERC 600x100	600	24"	100	4"	201781	1 U	201812	1 U

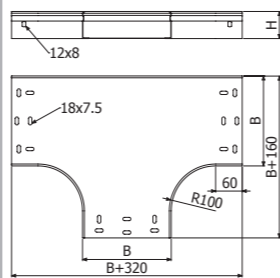

2 x JUER + 4/100 x B1 ( 204356 - EZ // 206826 - HDG // 204925 - i304)

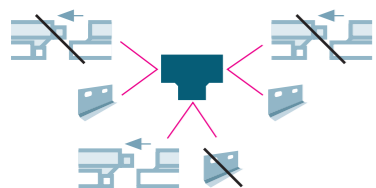

**TTERC**

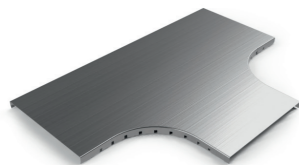

	B		PG		HDG	
	mm	inch	REF.	MOQ	REF.	MOQ
TTERC 100	100	4"	201844	1 U	201852	1 U
TTERC 150	150	6"	201845	1 U	201853	1 U
TTERC 200	200	8"	201846	1 U	201854	1 U
TTERC 300	300	12"	201848	1 U	201855	1 U
TTERC 400	400	16"	201849	1 U	201856	1 U
TTERC 500	500	20"	201850	1 U	201857	1 U
TTERC 600	600	24"	201851	1 U	201858	1 U

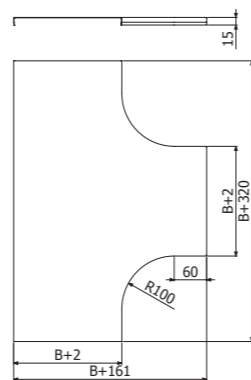

**CRERC**

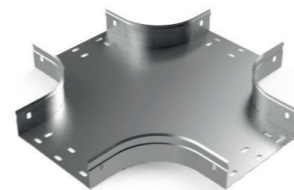

2 x JUER + 4/100 x B1 ( 204356 - EZ // 206826 - HDG // 204925 - i304)

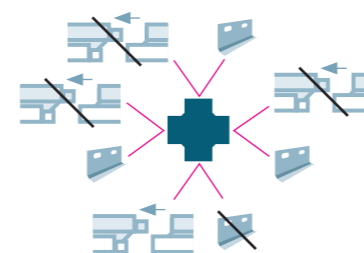

	B		H		PG		HDG	
	mm	inch	mm	inch	REF.	MOQ	REF.	MOQ
CRERC 100x35	100	4"	35	1 3/8"	201866	1 U	201897	1 U
CRERC 150x35	150	6"	35	1 3/8"	201867	1 U	201898	1 U
CRERC 200x35	200	8"	35	1 3/8"	201868	1 U	201899	1 U
CRERC 300x35	300	12"	35	1 3/8"	201869	1 U	201900	1 U
CRERC 100x60	100	4"	60	2 3/8"	201873	1 U	201904	1 U
CRERC 150x60	150	6"	60	2 3/8"	201874	1 U	201905	1 U
CRERC 200x60	200	8"	60	2 3/8"	201875	1 U	201906	1 U
CRERC 300x60	300	12"	60	2 3/8"	201877	1 U	201908	1 U
CRERC 400x60	400	16"	60	2 3/8"	201878	1 U	201909	1 U
CRERC 500x60	500	20"	60	2 3/8"	201879	1 U	201910	1 U
CRERC 600x60	600	24"	60	2 3/8"	201872	1 U	201911	1 U
CRERC 100x80	100	4"	80	3 1/7"	201881	1 U	201912	1 U
CRERC 150x80	150	6"	80	3 1/7"	201882	1 U	201913	1 U
CRERC 200x80	200	8"	80	3 1/7"	201883	1 U	201914	1 U
CRERC 300x80	300	12"	80	3 1/7"	201885	1 U	201916	1 U
CRERC 400x80	400	16"	80	3 1/7"	201886	1 U	201917	1 U
CRERC 500x80	500	20"	80	3 1/7"	201887	1 U	201918	1 U
CRERC 600x80	600	24"	80	3 1/7"	201880	1 U	201919	1 U
CRERC 100x100	100	4"	100	4"	201889	1 U	201920	1 U
CRERC 150x100	150	6"	100	4"	201890	1 U	201921	1 U
CRERC 200x100	200	8"	100	4"	201891	1 U	201922	1 U
CRERC 300x100	300	12"	100	4"	201893	1 U	201924	1 U
CRERC 400x100	400	16"	100	4"	201894	1 U	201925	1 U
CRERC 500x100	500	20"	100	4"	201895	1 U	201926	1 U
CRERC 600x100	600	24"	100	4"	201896	1 U	201927	1 U

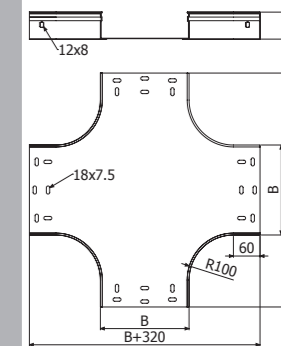

**TCRERC**

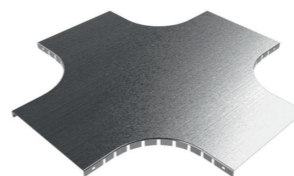

	B		PG		HDG	
	mm	inch	REF.	MOQ	REF.	MOQ
TCRERC 100	100	4"	201959	1 U	201967	1 U
TCRERC 150	150	6"	201960	1 U	201968	1 U
TCRERC 200	200	8"	201961	1 U	201969	1 U
TCRERC 300	300	12"	201963	1 U	201971	1 U
TCRERC 400	400	16"	201964	1 U	201972	1 U
TCRERC 500	500	20"	201965	1 U	201973	1 U
TCRERC 600	600	24"	201966	1 U	201974	1 U

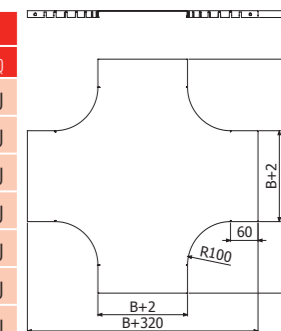



**BasorTRAY**  
ERE-MRE-FRE



**JUER-A**

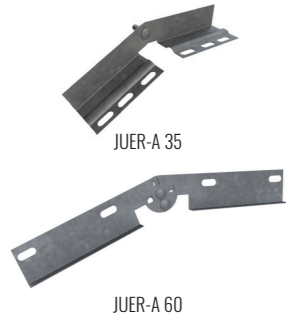

	H		PG		HDG		i304		i316	
	mm	inch	REF.	MOQ	REF.	MOQ	REF.	MOQ	REF.	MOQ
JUER-A 35	35	1 3/8"	203226	10 U	205298	1 U	-	-	-	-
JUER-A 60	60	2 3/8"	203229	15 U	204439	10 U	214246	14 U	-	-
JUER-A 80	80	3 1/7"	206327	10 U	-	-	-	-	-	-
JUER-A 100	100	4"	206209	10 U	206416	1 U	-	-	-	-

4/100 x B1 (204356 - EZ // 206826 - HDG // 204925 - i304 // 218388 - i316)

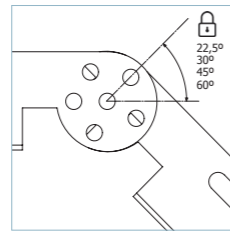
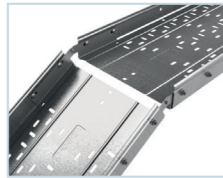
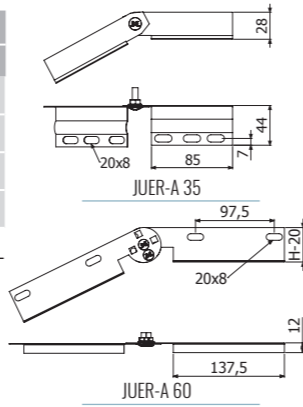

**JUER-BFR**

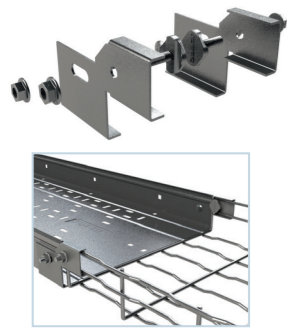

	i304	
	REF.	MOQ
JUER-BFR 60/65	207018	10 U

10

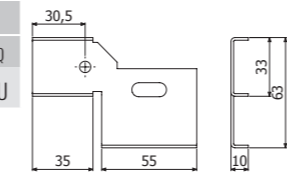

**JUER-B**

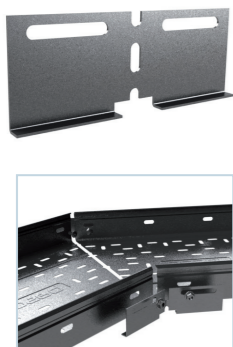

	H		PG		HDG		i304		i316	
	mm	inch	REF.	MOQ	REF.	MOQ	REF.	MOQ	REF.	MOQ
JUER-B 35	35	1 3/8"	207204	10 U	207208	10 U	-	-	-	-
JUER-B 60	60	2 3/8"	207205	30 U	204440	10 U	214250	30 U	-	-
JUER-B 80	80	3 1/7"	207206	10 U	-	-	-	-	-	-
JUER-B 100	100	4"	207207	10 U	207210	10 U	-	-	-	-

2/100 x B1 (204356 - EZ // 206826 - HDG // 204925 - i304 // 218388 - i316)

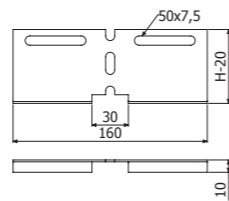

**BasorTRAY**  
ERE-MRE-FRE



**JUER-U**



	H		PG		i304		i316
	mm	inch	REF.	MOQ	REF.	MOQ	
JUER-U 60	60	2 3/8"	205740	6 U	214241	6 U	
JUER-U 100	100	4"	214243	6 U	214242	6 U	

2/100 x B1 (204356 - EZ / 206826 - HDG / 204925 - i304)



**PBCH-20**



	e	L	PVC	
			REF.	MOQ
PBCH-20 1MM	≤1	20	2/10086	1 U

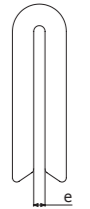
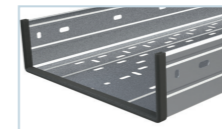

**B-1**



	L		PG		HDG		i304	
	mm	N-m	REF.	MOQ	REF.	MOQ	REF.	MOQ
B1-100	14	6	204356	1 U	206826	1 U	-	-
B1-100	20	6	-	-	-	-	204925	1 U

10

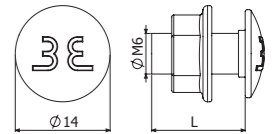

**TT / TTL (ACC)**

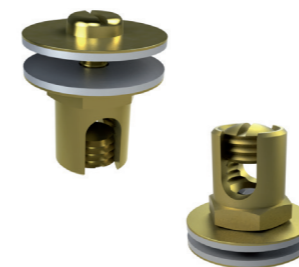

TT

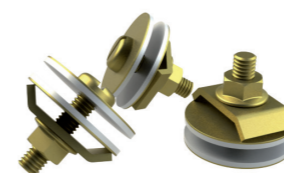

TTL

	Smin	Smax	Dcable	A	B	LTN	
	mm <sup>2</sup>	mm <sup>2</sup>	mm	mm	mm	REF.	MOQ
TT 4-35	4	35	2,2 a 8	22	18	206796	10 U
TT 35-95	35	95	8 a 12	30	24	206797	10 U
TTL 10-35	10	35	4 a 8	25	-	208189	20 U

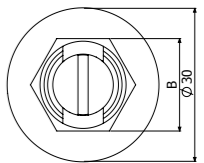
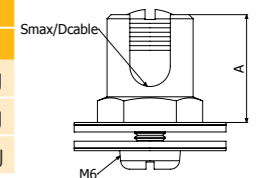

TT

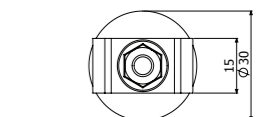
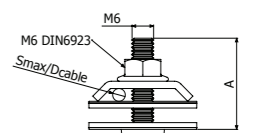

TTL





# BasorFIL

BasorFIL  
BFR

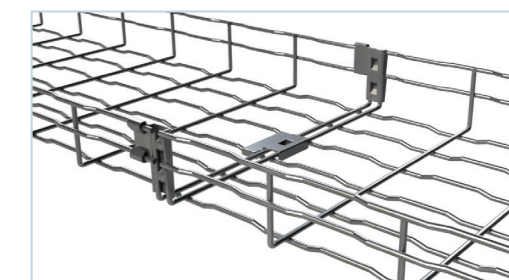
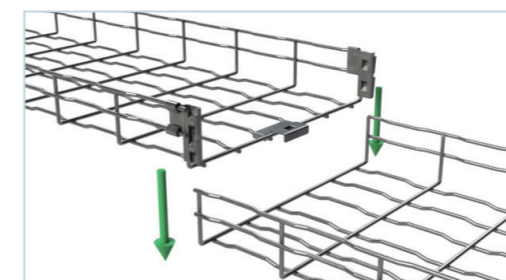
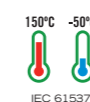

Filling Area					
B		H65 (2")		H105 (4")	
mm	inch	cm <sup>2</sup>	in <sup>2</sup>	cm <sup>2</sup>	in <sup>2</sup>
60	2"	25	3,9	-	-
100	4"	51	7,8	81	12,6
150	6"	81	12,5	134	20,7
200	8"	111	17,2	186	28,8
300	12"	170	26,4	291	45,1
400	16"	228	35,4	396	61,4
450	18"	256	39,7	448	69,5
500	20"	286	39,7	501	77,7
600	24"	345	44,3	606	93,9

**BF2R H65**

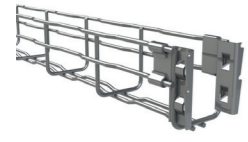

BF2R-2F 60x65



BF2R H65  
L = 3 m (10 ft)

	B		H			EZ		EZ 1000	
	mm	inch	mm	inch		REF	MOQ	REF	MOQ
BF2R-2F 60X65	60	2"	65	2"	0	207389	24 M	217354	24 M
BF2R 100X65	100	4"	65	2"	0	207248	24 M	217355	24 M
BF2R 150X65	150	6"	65	2"	0	207249	18 M	217356	18 M
BF2R 200X65	200	8"	65	2"	0	207250	18 M	217357	18 M
BF2R 300X65	300	12"	65	2"	1	207251	18 M	217358	18 M
BF2R 400X65	400	16"	65	2"	1	207394	6 M	217359	6 M
BF2R 500X65	500	20"	65	2"	1	207395	6 M	217361	6 M
BF2R 600X65	600	24"	65	2"	1	207396	6 M	217362	6 M

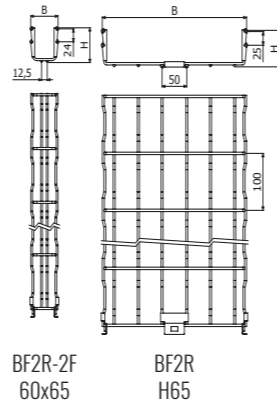

BF2R-2F  
60x65

BF2R  
H65



**TERE (BF2R H65)**

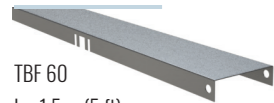

TBF 60  
L = 1,5 m (5 ft)

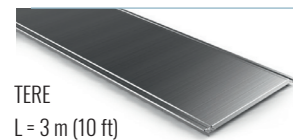
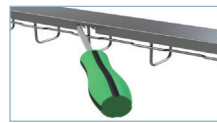

TERE  
L = 3 m (10 ft)  
100/150/200/300



	B		PG		HDG	
	mm	inch	REF	MOQ	REF	MOQ
TBF 60	60	2"	206044	10 M	203614	10 M
TERE 100	100	4"	201312	24 M	201321	3 M
TERE 150	150	6"	201313	24 M	201322	3 M
TERE 200	200	8"	201314	24 M	201323	3 M
TERE 300	300	12"	201316	18 M	201325	3 M
TERE 400 2M	400	16"	201317	12 M	201326	2 M
TERE 500 2M	500	20"	201318	8 M	201327	2 M
TERE 600 2M	600	24"	201319	8 M	201328	2 M

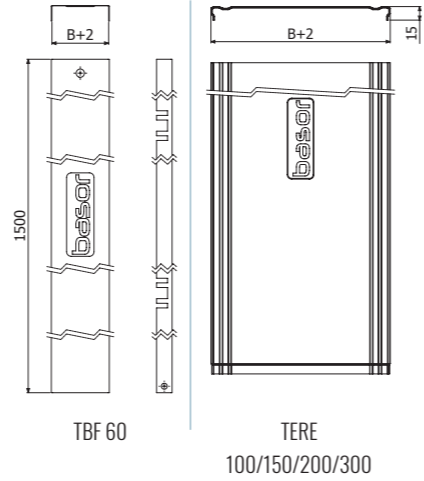

TBF 60

TERE  
100/150/200/300



**BF2R H105**



L = 3 m (10 ft)



	B		H			EZ		EZ 1000	
	mm	inch	mm	inch		REF	MOQ	REF	MOQ
BF2R 100X105	100	4"	105	4"	0	207914	24 M	217363	24 M
BF2R 150X105	150	6"	105	4"	0	207915	18 M	217364	18 M
BF2R 200X105	200	8"	105	4"	0	207397	12 M	217365	12 M
BF2R 300X105	300	12"	105	4"	1	207398	12 M	217366	12 M
BF2R 400X105	400	16"	105	4"	1	207399	6 M	217367	6 M
BF2R 500X105	500	20"	105	4"	2	207400	6 M	217369	6 M
BF2R 600X105	600	24"	105	4"	2	207401	6 M	217370	6 M

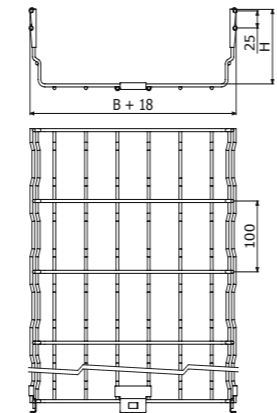

**TEBFR (BF2R H105)**

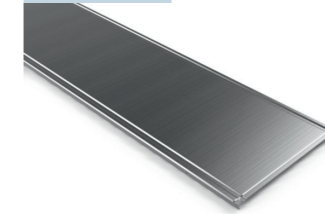

L = 3 m (10 ft)



	B		PG		HDG	
	mm	inch	REF	MOQ	REF	MOQ
TEBFR 100	100	4"	209789	3 M	209886	3 M
TEBFR 150	150	6"	209790	3 M	209887	3 M
TEBFR 200	200	8"	209791	3 M	209888	3 M
TEBFR 300	300	12"	209792	3 M	209889	3 M
TEBFR 400	400	16"	209793	3 M	209890	3 M
TEBFR 500	500	20"	209794	3 M	209891	3 M
TEBFR 600	600	24"	209795	3 M	209892	3 M

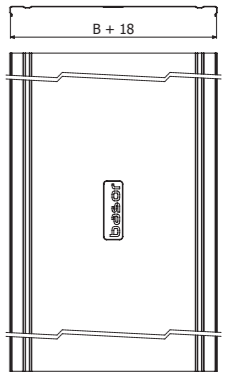

# BasorFIL

## BFR

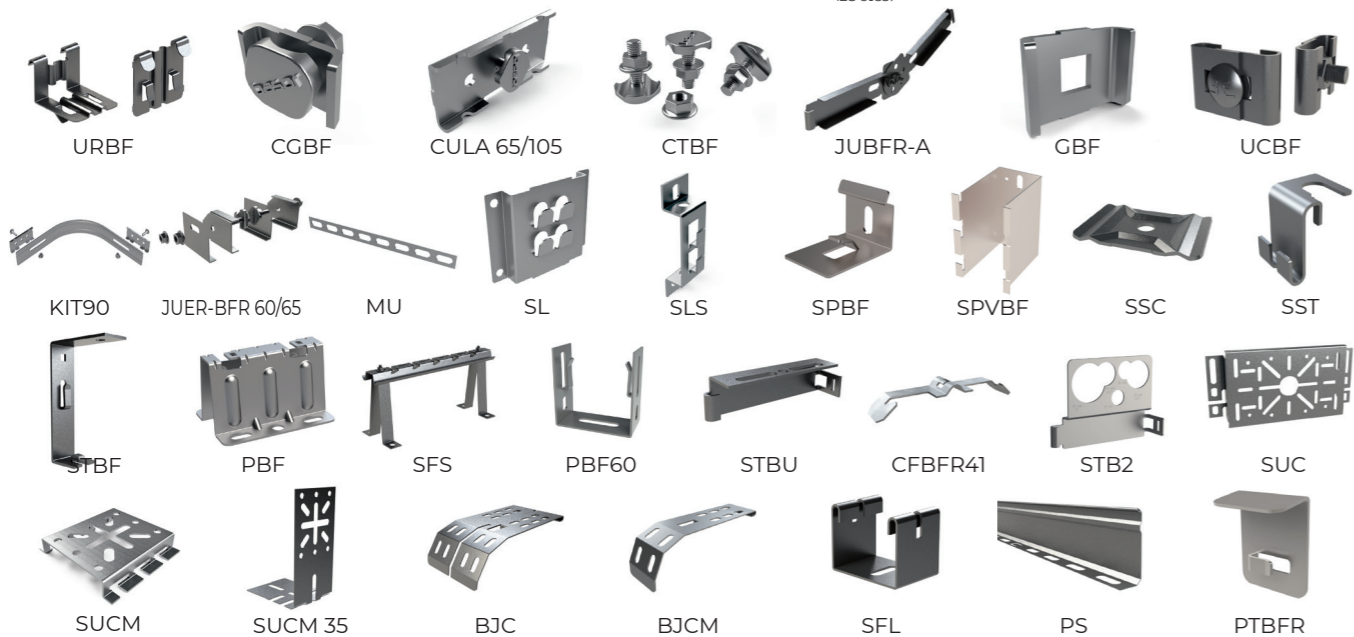
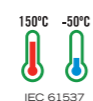
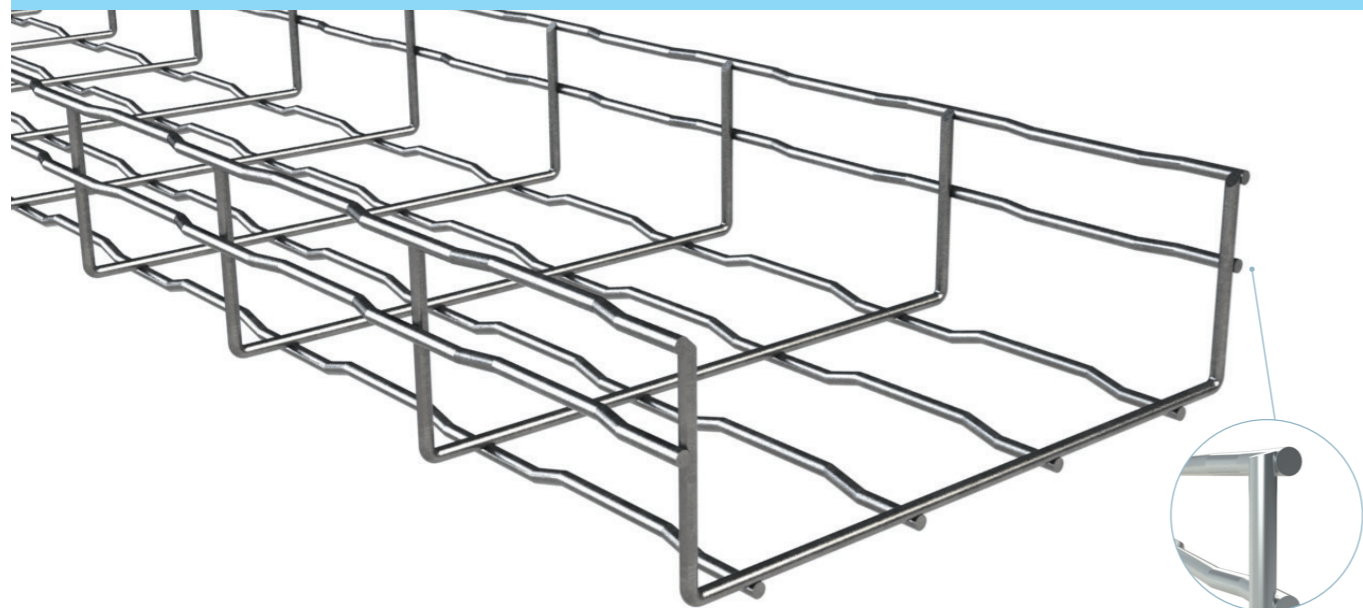

Filling Area									
B		H35 (1 3/8")		H65 (2")		H105 (4")		H150 (6")	
mm	inch	cm <sup>2</sup>	in <sup>2</sup>	cm <sup>2</sup>	in <sup>2</sup>	cm <sup>2</sup>	in <sup>2</sup>	cm <sup>2</sup>	in <sup>2</sup>
60	2"	12	1,8	25	3,9	-	-	-	-
100	4"	23	3,5	51	7,8	-	-	-	-
150	6"	36	5,6	81	12,5	146	22,6	276	42,8
200	8"	50	7,7	111	17,2	199	30,8	424	65,7
300	12"	77	11,9	170	26,4	305	47,3	574	89,1
400	16"	-	-	228	35,4	410	63,6	649	100,7
500	20"	-	-	286	39,7	518	71,9	725	112,4
600	24"	-	-	345	44,3	625	80,2	875	135,7

# BasorFIL

## BFR

### BFR H35 EZ-HDG

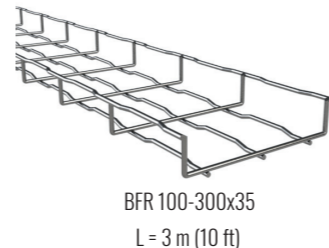
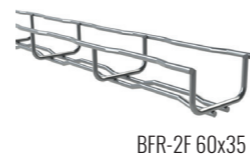
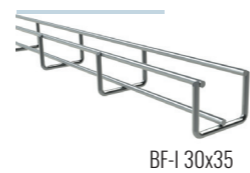

	B		H		EZ		HDG70	
	mm	inch	mm	inch	REF	MOQ	REF	MOQ
BF-I 30X35	30	1"	35	1 3/8"	209804	24 M	-	-
BFR-2F 60X35	60	2"	35	1 3/8"	206407	24 M	208230	3 M
BFR 100X35	100	4"	35	1 3/8"	203616	24 M	200286	3 M
BFR 150X35	150	6"	35	1 3/8"	203617	18 M	200287	3 M
BFR 200X35	200	8"	35	1 3/8"	203618	12 M	200288	3 M
BFR 300X35	300	12"	35	1 3/8"	203619	18 M	200289	3 M

≤200 2x CGBF (204364-EZ / 204360-HDG)  
300 3x CGBF (204364-EZ / 204360-HDG)

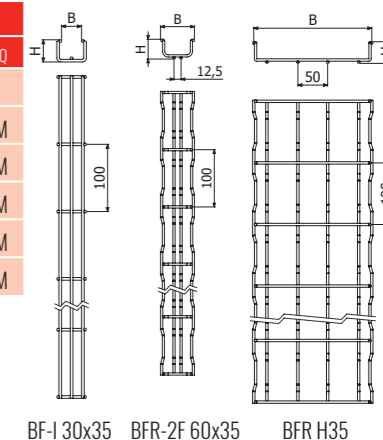

### BFR H35 i304-i316

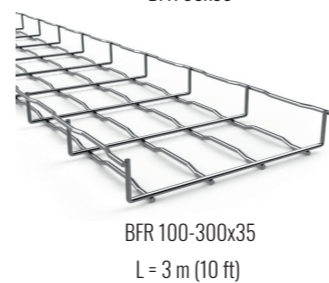
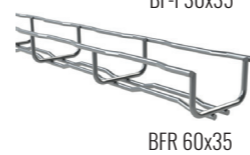
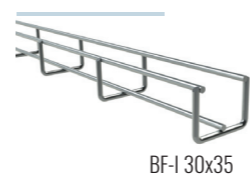

	B		H		i304		i316	
	mm	inch	mm	inch	REF	MOQ	REF	MOQ
BF-I 30X35	30	1"	35	1 3/8"	209803	24 M	-	-
BFR 60X35	60	2"	35	1 3/8"	206516	24 M	208233	3 M
BFR 100X35	100	4"	35	1 3/8"	200303	24 M	207415	3 M
BFR 150X35	150	6"	35	1 3/8"	200304	3 M	207416	3 M
BFR 200X35	200	8"	35	1 3/8"	200305	12 M	207417	3 M
BFR 300X35	300	12"	35	1 3/8"	200306	18 M	207418	3 M

≤ 200 2x CGBF (204915-i304 / 205358-i316)  
≥300 3x CGBF (204915-i304 / 205358-i316)

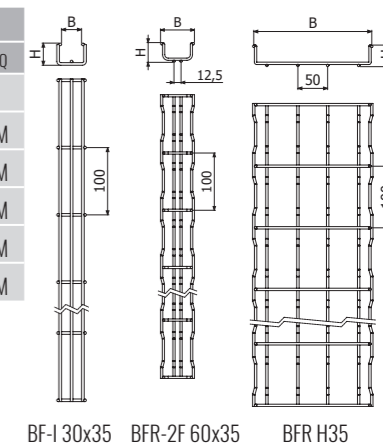

### BFR H65 HDG

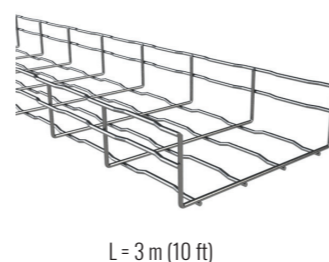
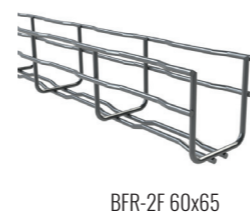

	B		H		HDG70	
	mm	inch	mm	inch	REF	MOQ
BFR-2F 60X65	60	2"	61	2"	215576	3 M
BFR 100X65	100	4"	65	2"	200291	3 M
BFR 150X65	150	6"	65	2"	200292	3 M
BFR 200X65	200	8"	65	2"	200293	3 M
BFR 300X65	300	12"	65	2"	200294	3 M
BFR 400X65	400	16"	65	2"	200295	3 M
BFR 500X65	500	20"	65	2"	200296	3 M
BFR 600X65	600	24"	65	2"	200297	3 M

≤ 200 2x URBF (206219-HDG)  
≥300 2x URBF (206219-HDG)  
+ 1x CGBF (204360-HDG)

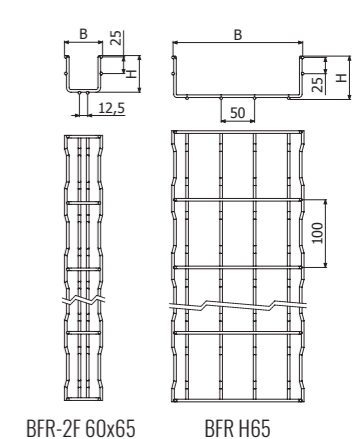

**BFR H65 i304-i316**

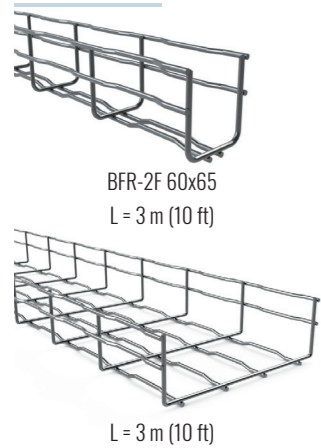

	B		H		i304		i316	
	mm	inch	mm	inch	REF	MOQ	REF	MOQ
BFR-2F 60X65	60	2"	65	2"	200307	24 M	207419	3 M
BFR 100X65	100	4"	65	2"	200308	24 M	207420	3 M
BFR 150X65	150	6"	65	2"	200309	18 M	207421	3 M
BFR 200X65	200	8"	65	2"	200310	18 M	207422	3 M
BFR 300X65	300	12"	65	2"	200311	18 M	207423	3 M
BFR 400X65	400	16"	65	2"	200312	6 M	207424	3 M
BFR 500X65	500	20"	65	2"	200313	6 M	207425	3 M
BFR 600X65	600	24"	65	2"	200314	6 M	207426	3 M

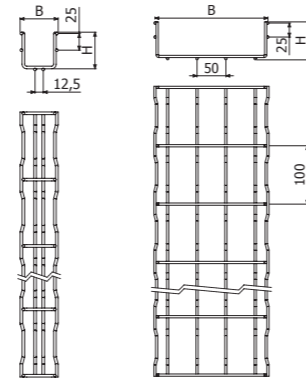

≤ 200 2x CGBF (204915-i304 / 205358-i316)  
 ≥ 300 3x CGBF (204915-i304 / 205358-i316)



BFR-2F 60x65 BFR H65

**EBFR H105 HDG**

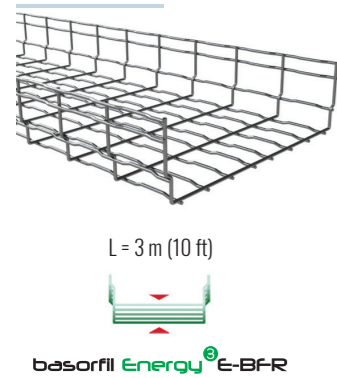

	B		H		HDG70	
	mm	inch	mm	inch	REF	MOQ
EBFR 100X105	100	4"	105	4"	207913	3 M
EBFR 150X105	150	6"	105	4"	207919	3 M
EBFR 200X105	200	8"	105	4"	207333	3 M
EBFR 300X105	300	12"	105	4"	207334	3 M
EBFR 400X105	400	16"	105	4"	207335	3 M
EBFR 450X105	450	18"	105	4"	209548	3 M
EBFR 500X105	500	20"	105	4"	207336	3 M
EBFR 600X105	600	24"	105	4"	207337	3 M

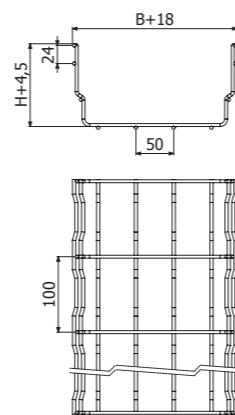

≤ 200 2x URBF (206219-HDG)  
 ≥ 300 2x URBF (206219-HDG)  
 + 1x CGBF (204360-HDG)



**BFR H105 i304-i316**

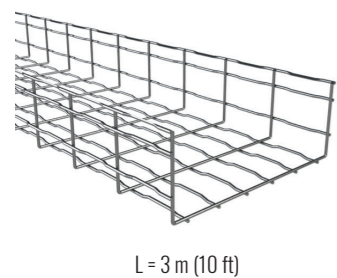

	B		H		i304		i316	
	mm	inch	mm	inch	REF	MOQ	REF	MOQ
BFR 100X105	100	4"	105	4"	208769	12 M	-	-
BFR 200X105	200	8"	105	4"	200315	12 M	207427	3 M
BFR 300X105	300	12"	105	4"	200316	12 M	207428	3 M
BFR 400X105	400	16"	105	4"	200317	6 M	207429	3 M
BFR 500X105	500	20"	105	4"	200318	6 M	207430	3 M
BFR 600X105	600	24"	105	4"	200319	6 M	207431	3 M

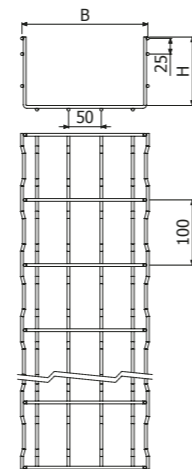

≤ 200 2x CGBF (204915-i304 / 205358-i316)  
 ≥ 300 3x CGBF (204915-i304 / 205358-i316)



**TERE**



	B		PG		HDG		i304	
	mm	inch	REF	MOQ	REF	MOQ	REF	MOQ
TERE 100	100	4"	201312	24 M	201321	3 M	204560	12 M
TERE 150	150	6"	201313	24 M	201322	3 M	205123	12 M
TERE 200	200	8"	201314	24 M	201323	3 M	204561	12 M
TERE 300	300	12"	201316	18 M	201325	3 M	204716	12 M
TERE 400 2M	400	16"	201317	12 M	201326	2 M	-	-
TERE 500 2M	500	20"	201318	8 M	201327	2 M	-	-
TERE 600 2M	600	24"	201319	8 M	201328	2 M	-	-
TERE 400 3M	400	16"	-	-	-	-	204931	6 M
TERE 500 3M	500	20"	-	-	-	-	204562	6 M
TERE 600 3M	600	24"	-	-	-	-	205357	6 M

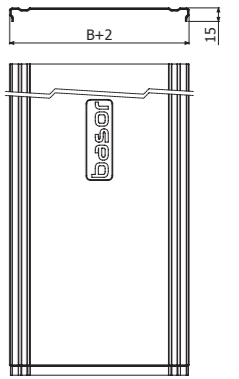

**TBF 60**

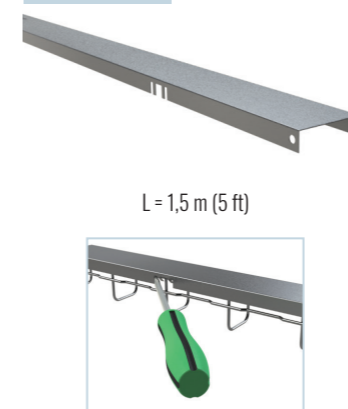

	B		PG		HDG		i304	
	mm	inch	REF	MOQ	REF	MOQ	REF	MOQ
TBF 60 1,5M	60	2"	206044	10 M	203614	10 M	205594	10 M

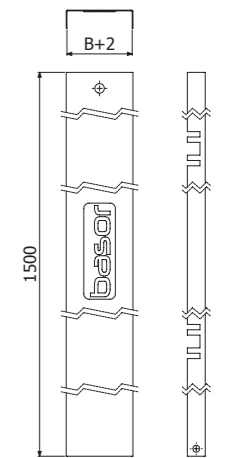

**URBF**



	EZ		HDG	
	REF	MOQ	REF	MOQ
URBF 65/105	206217	50 U	206219	50 U
URBF 35	207271	25 U	207272	25 U

65/105 105 UR BFR 65/105 EBFR 105

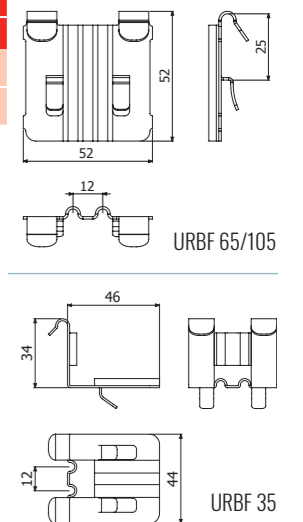

**CGBF**



	Pap	EZ		HDG		i304		i316	
		REF	MOQ	REF	MOQ	REF	MOQ	REF	MOQ
CGBF	6	204364	100 U	204360	100 U	204915	100 U	205358	100 U

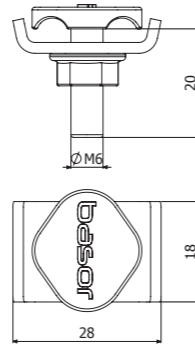

**CULA**



	Pap	EZ		HDG		i304		i316
		REF	MOQ	REF	MOQ	REF	MOQ	
CULA 65/105	6	204919	25 U	204363	25 U	204921	25 U	

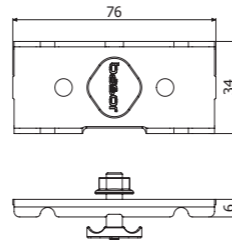

**CTBF**

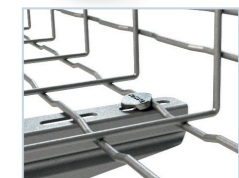

	Pap	EZ		HDG		i304		i316	
		REF	MOQ	REF	MOQ	REF	MOQ	REF	MOQ
CTBF	6	204362	100 U	207132	100 U	204923	100 U	208229	100 U

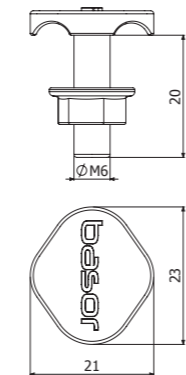

**JUBFR-A**



	PG	i304		i316	
		REF	MOQ	REF	MOQ
JUBFR-A 65/105		209868	1 U	209869	1 U

2 x GBF ( 200337-EZ / 200340-i304)  
+ 2/100 x B1 ( 204356-EZ / 204925-i304)

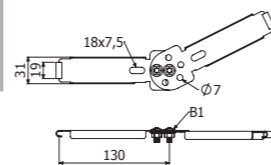

**GBF**

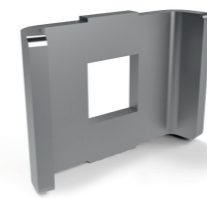

	Pap	EZ		HDG		i304		i316	
		REF	MOQ	REF	MOQ	REF	MOQ	REF	MOQ
GBF	6	200337	100 U	200339	100 U	200340	100 U	201104	100 U

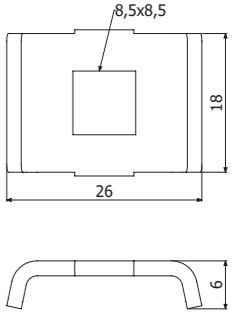

**UCBF**

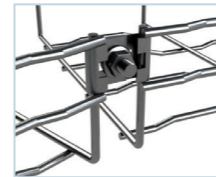

	Pap	EZ		HDG		i304	
		REF	MOQ	REF	MOQ	REF	MOQ
UCBF	6	205059	100 U	205060	100 U	205093	100 U

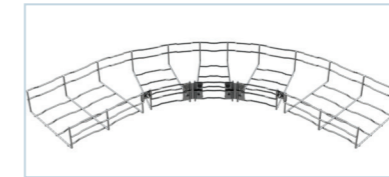
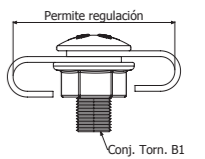
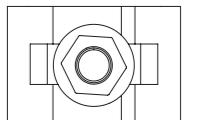

**KIT90**

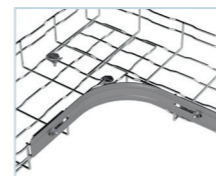

	PG	
	REF	MOQ
KIT90	218641	2 U



2 x (ULA 65 EZ + ISO7380-2 M6x25 EZ + DIN6923 M6 EZ)

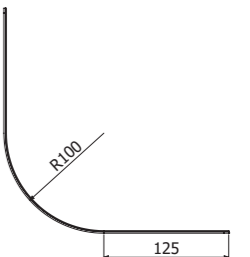

**JUER-BFR**



	i304		i316	
	REF	MOQ	REF	MOQ
JUER-BFR 60/65	207018	10 U		



2 x CTBF + 2/100 x B1

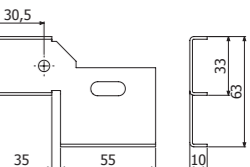

**MU**

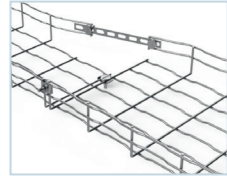

	L mm	PG		i304		i316	
		REF	MOQ	REF	MOQ	REF	MOQ
MU 500	500	200357	10 U	209872	10 U	214244	10 U
MU 275	275	210007	10 U	☎		☎	

🔧 2 x CTBF (204362-EZ) / (204923-I304) / (208229-I316)

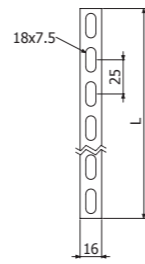

**SL**

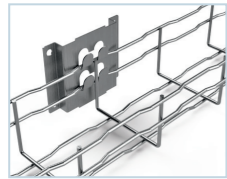

	PG		HDG		i304	
	REF	MOQ	REF	MOQ	REF	MOQ
SL	200355	18 U	200365	10 U	200375	1 U

🔧 Mod. 60x65 - 100x65

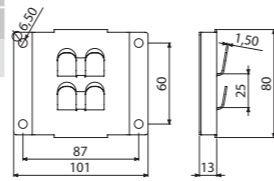

**SLS**



	PG		HDG		i304		i316	
	REF	MOQ	REF	MOQ	REF	MOQ	REF	MOQ
SLS	200360	36 U	200370	36 U	200380	1 U	218561	1 U

🔧 BFR/BF2R 60x65 - 100x65

🔧 VR6/VR8 - BFR/BF2R 60x65..200x65

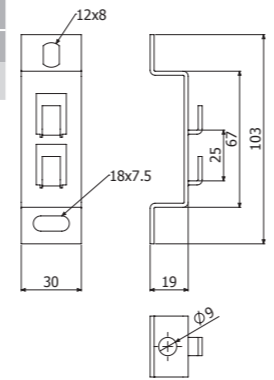

**SPBF**

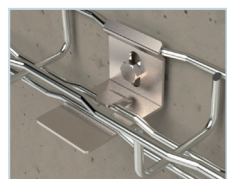

	PG		i304	
	REF	MOQ	REF	MOQ
SPBF 60-100x35	217591	1 U	217595	1 U

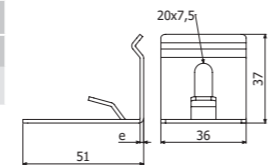

**SPVBF**

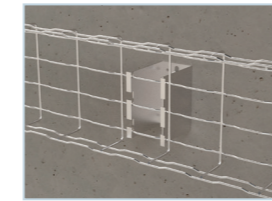
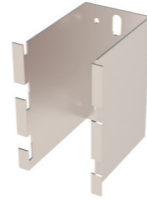

	H	A	e	PG		i304	
				REF	MOQ	REF	MOQ
SPVBF 100/70	100	70	1,5	218716	1 U	218717	1 U
SPVBF 100/120	100	120	1,5	218705	1 U	218706	1 U

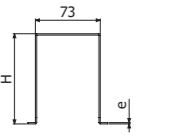
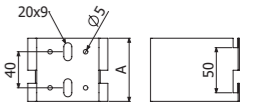

SPVBF 100/70

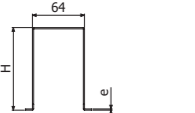
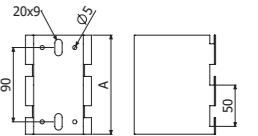

SPVBF 100/120

**SSC**

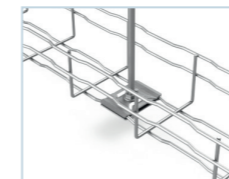
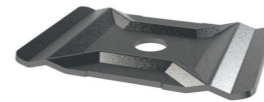

	D mm	EZ		HDG		i304		i316
		REF	MOQ	REF	MOQ	REF	MOQ	
SSC 8/10	10,5	202064	50 U	200363	50 U	200373	50 U	☎

🗨️ SSC 8/10 -> M8/M10

🔧 60x35, 150x35, 60x65.

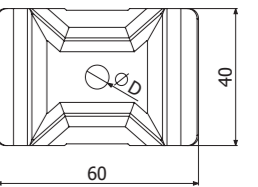
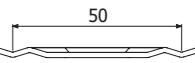

**SST**



	PG		i316
	REF	MOQ	
SST	205724	25 U	☎

🔧 VR8/VR10

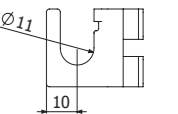
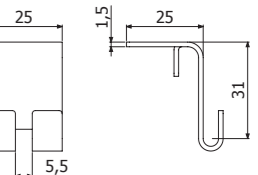

STBF



	A mm	C mm	PG	
			REF	MOQ
STBF 100X35	45	90	209675	1 U
STBF 60X65	45	120	217314	1 U
STBF 100X65	70	120	200886	25 U

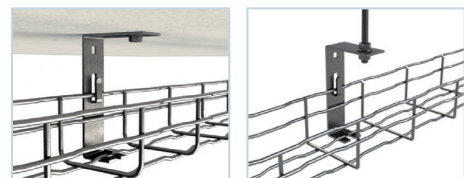
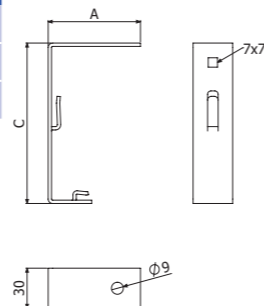

PBF

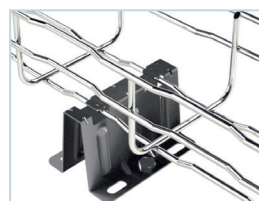

	e mm	CTA kg	CTA lb	PG		HDG		i304		i316
				REF	MOQ	REF	MOQ	REF	MOQ	
PBF	1	250	551	205590	12 U	204397	27 U	208777	27 U	

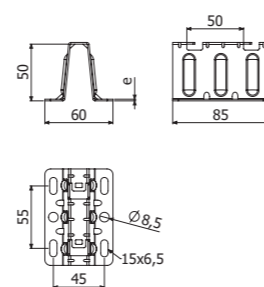

SFS



	PG	
	REF	MOQ
SFS 140	205602	24 U

C-SVO + 2 x SFS + 2/100 x B1

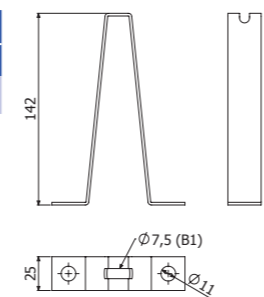

PBF60



CFBFR41



STB2

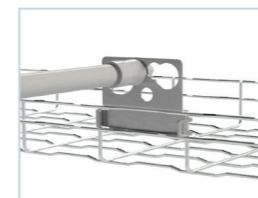

STBU

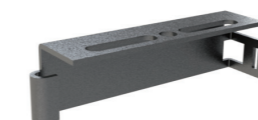

	B		i304	
	mm	inch	REF	MOQ
PBF60	60	2"	207304	1 U

PBF60

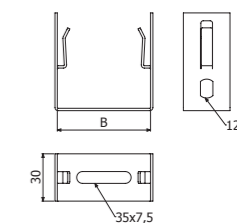

	i301		i316
	REF	MOQ	
CFBFR41	210284	100 U	

CFBFR41

SP, SP3S, 41/82

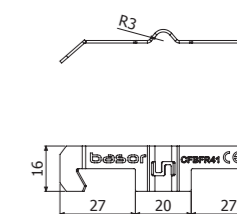

	PG		HDG		i304		i316
	REF	MOQ	REF	MOQ	REF	MOQ	
STB2 12-32	218798	20 U	218799	1 U	218800	1 U	

STB2 12-32

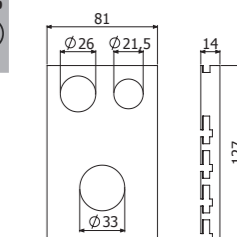

	PG	
	REF	MOQ
STBU	205834	10 U

STBU

65 / 105  
105

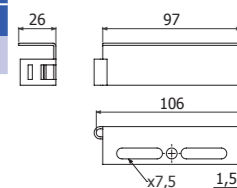

**SUC**

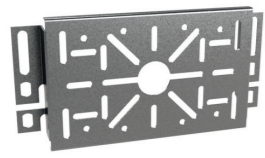

PG		HDG		i304		i316
REF	MOQ	REF	MOQ	REF	MOQ	
SUC	200358	4 U	200368	4 U	200378	4 U

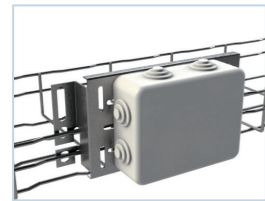
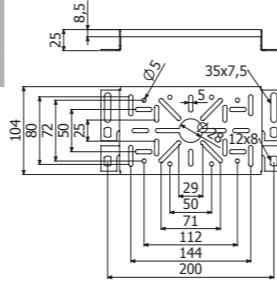
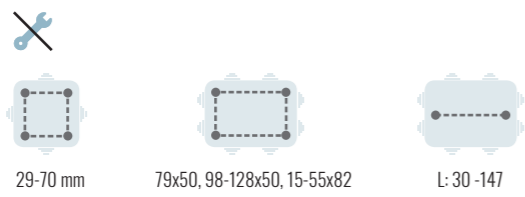

**SUCM**

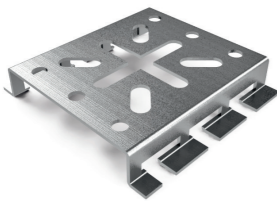

PG		HDG		i304		i316
REF	MOQ	REF	MOQ	REF	MOQ	
SUCM	200359	20 U	200369	20 U	200379	20 U

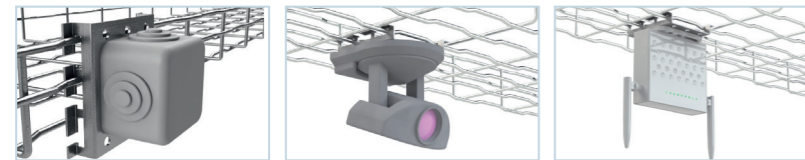
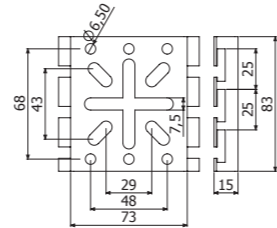
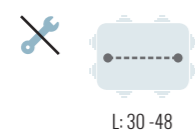

**SUCM 35**

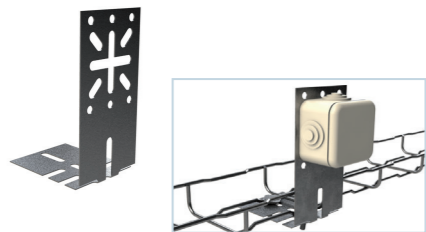

PG		HDG		i304
REF	MOQ	REF	MOQ	
SUCM 35	206343	10 U	207256	10 U

2 x CTBF (204362-EZ // 207132-HDG // 204923-i304)

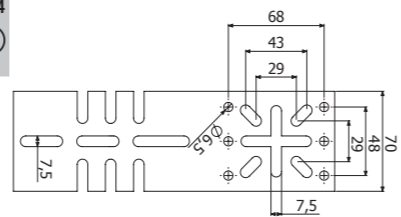

**BJC**

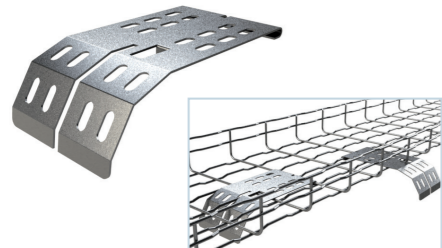

PG		HDG		
REF	MOQ	REF	MOQ	
BJC	206451	1 U	206452	1 U

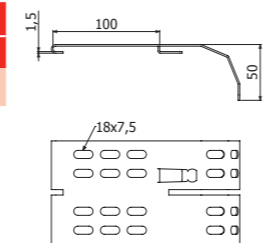

**BJCM**



PG	
REF	MOQ
BJCM	209807

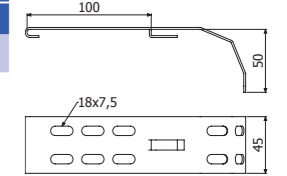

**SFL**

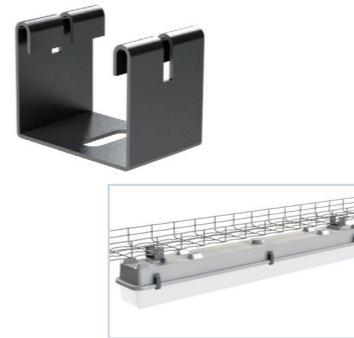

PG		i304		
REF	MOQ	REF	MOQ	
SFL	205906	1 U	211308	1 U

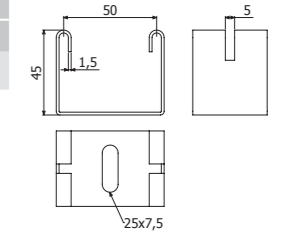

**PS**

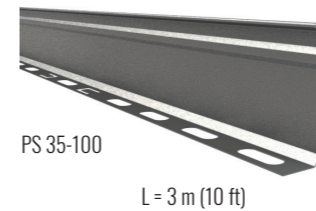

PS 35-100  
L = 3 m (10 ft)

	H		PG		HDG		i304		i316	
	mm	inch	REF	MOQ	REF	MOQ	REF	MOQ	REF	MOQ
PS 35	35	1 3/8"	203476	30 M	203479	30 M	211227	3 M	-	-
PS 60	60	2"	202066	30 M	203480	30 M	203645	3 M	215545	3 M
PS 80	80	3 1/7"	203477	30 M	203481	30 M	211228	3 M	-	-
PS 100	100	4"	203478	30 M	203482	30 M	205138	6 M	-	-

H 35/60/80/100

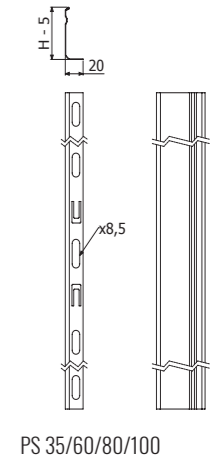
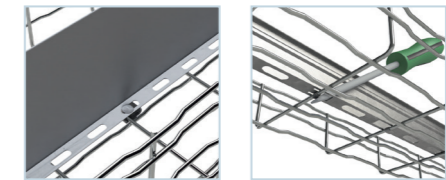

**PTBFR**

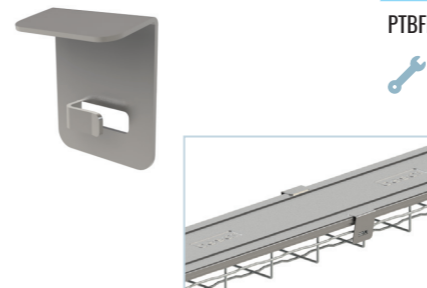

PG		i304		i316
REF	MOQ	REF	MOQ	
PTBFR	210253	20 U	210254	20 U

4 x PTBFR => 1 x TERE (BFR)

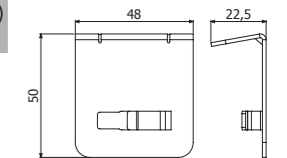

**A**

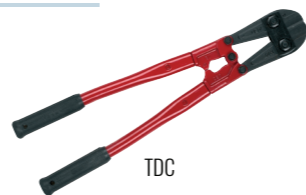

TDC



BPZ

	REF	MOQ
TDC	205066	1 U
BPZ 400 ml	207224	1 U



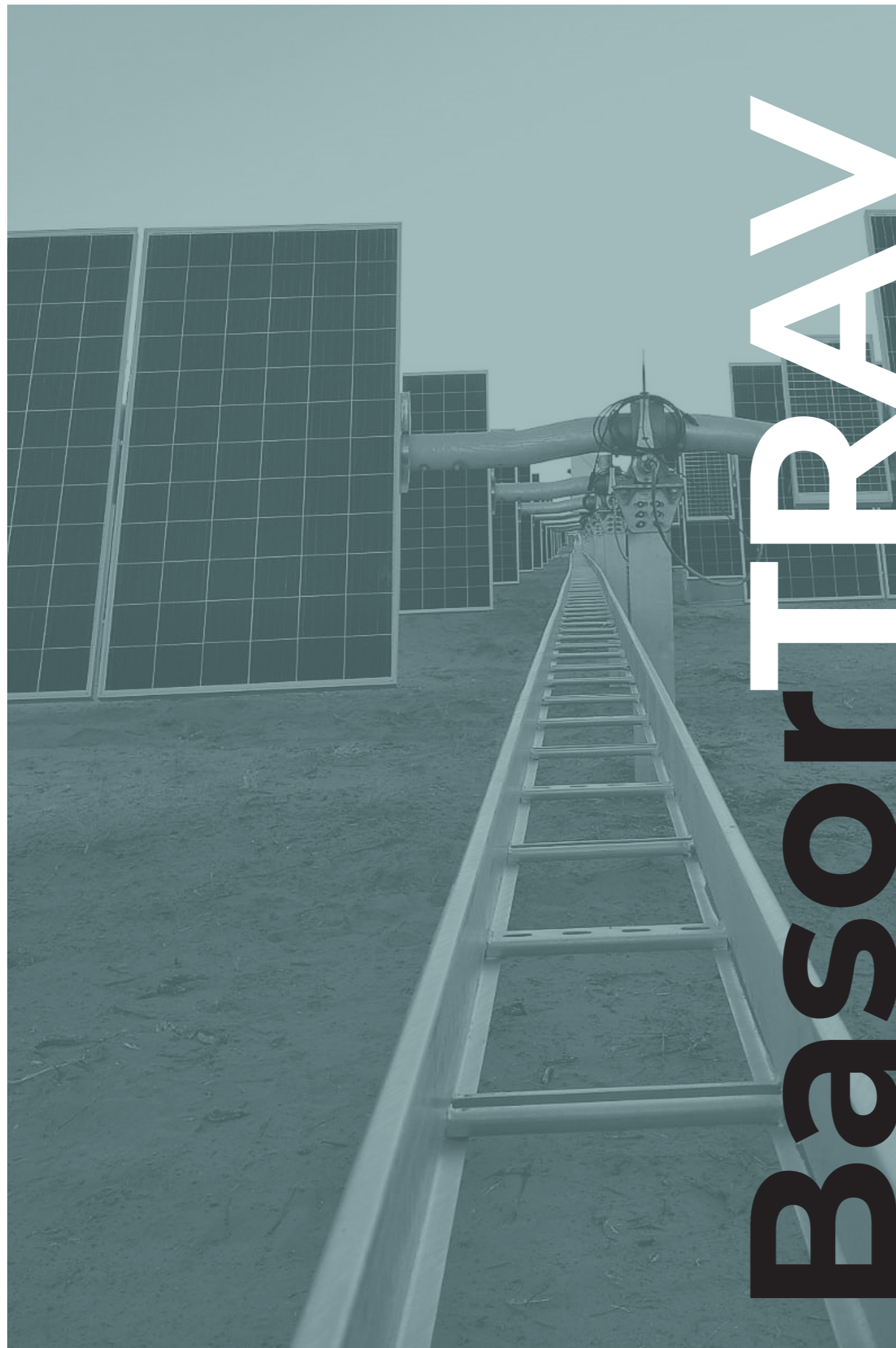

# BasorTRAV

## BasorTRAV FE 60

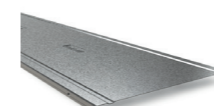
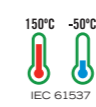
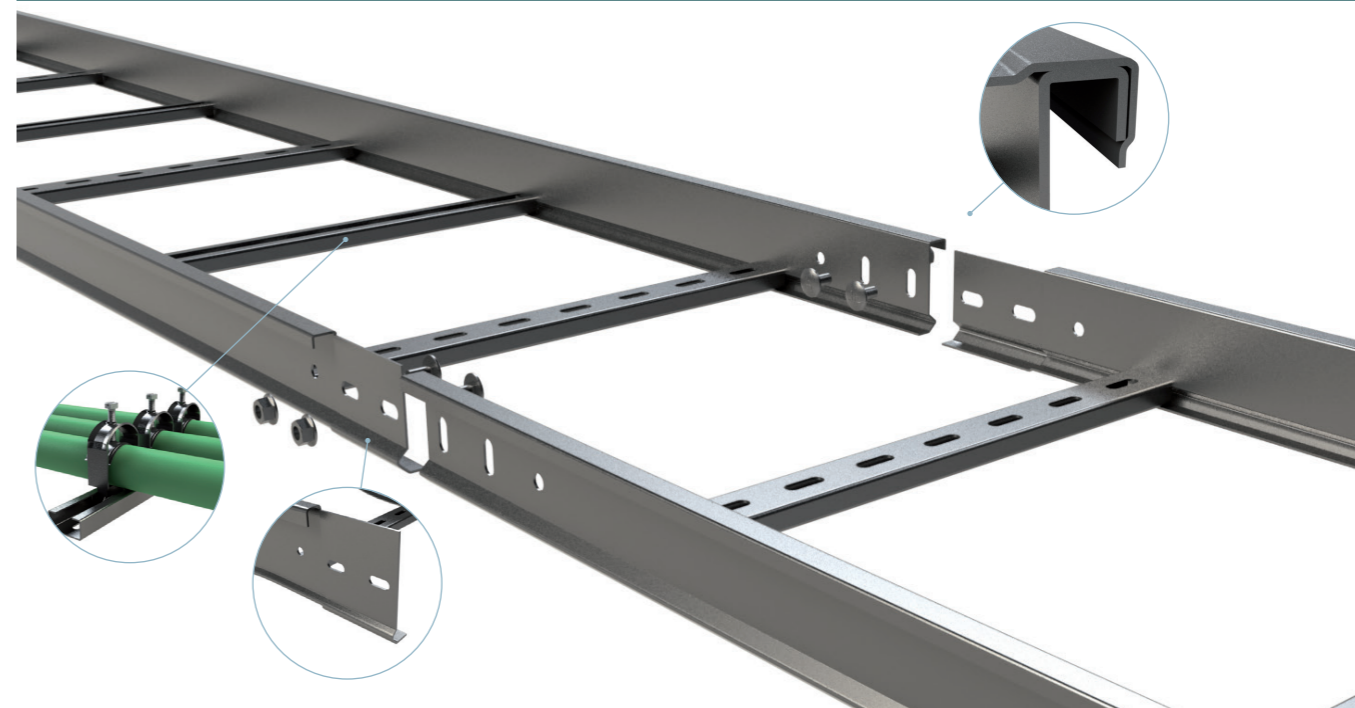

TFE/TFEL



CPFE-125 H60



CCXFE-125 H60



TEFE-125 H60



CRFE-125 H60



REFE H60

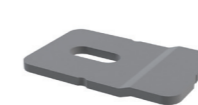

BFE



PTFE



JUFE H60



JUFE-A H60



JUFE-B H60

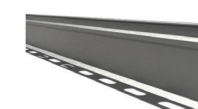

PS



BJCFE



B2

Filling Area			
B		H60 (2 3/8")	
mm	inch	cm <sup>2</sup>	in <sup>2</sup>
100	4"	45	7,0
150	6"	67	10,4
200	8"	89	13,8
300	12"	134	20,8
400	16"	178	27,6
500	20"	223	36,1
600	24"	267	41,4



**BFE**

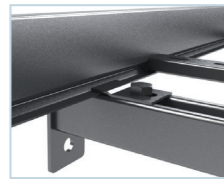
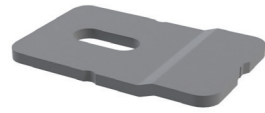

	e mm	HDG	
		REF	MOQ
BFE 6/8	3	200863	25 U
BFE 10	3	200864	25 U

- BFE 6/8 --> SHL --> B2 (206792 - HDG)
- SP/SPD + BFE 10 --> DIN933 10X30 (217547- i304) + TM41 M10 (217584 - HDG) + DIN125 M10 (217542-i304)

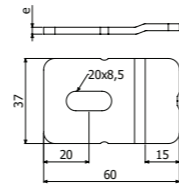

BFE 6/8

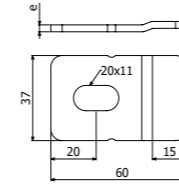

BFE 10

**PTFE**

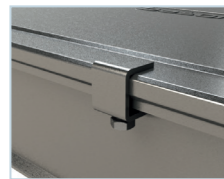

PTFE	Pap	e	i304	
	N/m	mm	REF	MOQ
	6	2	207054	30 U

- 4 x PTFE => 1 x TFE

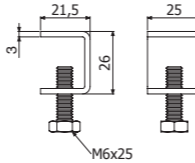

**JUFE H60**



JUFE 60/75	H		e	HDG	
	mm	inch	mm	REF	MOQ
	75	3"	2	200854	10 U

- 4/100 x B2 (206792 - HDG)

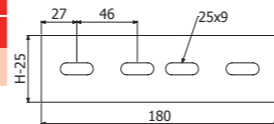

**JUFE-A H60**



JUFE-A 60/75	H		e	HDG	
	mm	inch	mm	REF	MOQ
	75	3"	2	200857	1 U

- 4/100 x B2 (206792 - HDG)

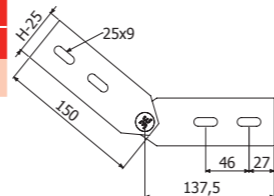

**JUFE-B H60**



**PS**

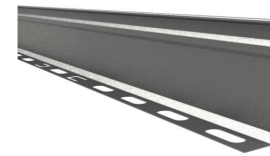

L = 3 m (10 ft)

**BJCFE**



**B2**



JUFE-BB 60/75	H		e	HDG	
	mm	inch	mm	REF	MOQ
	75	3"	2	200860	1 U

- 4/100 x B2 (206792 - HDG)

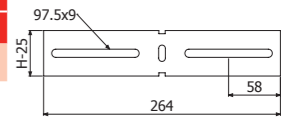

PS 35	H		HDG	
	mm	inch	REF	MOQ
	35	1 3/8"	203479	30 M

- 3 x (ISO7380-2 M8x30 (218823) + DIN934 M8 (217603))
- PS 35-> H60.

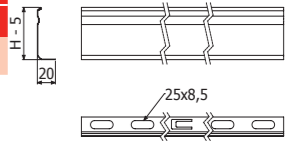

BJCFE 100	e mm	HDG	
		REF	MOQ
BJCFE 100	1,5	210021	2 U
BJCFE 150	1,5	210022	2 U
BJCFE 200	1,5	210023	2 U
BJCFE 300	1,5	210024	2 U
BJCFE 400	1,5	210025	2 U
BJCFE 500	1,5	210026	2 U
BJCFE 600	1,5	210027	2 U

- 2/100 x B2 (206792 - HDG)

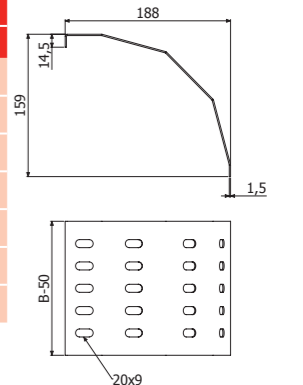

B2-100	Pap	HDG		i304	
	N/m	REF	MOQ	REF	MOQ
	15	206792	1 U	205392	1 U

- 13

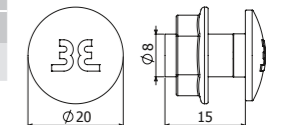

# BasorTRAV FE

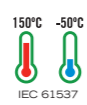
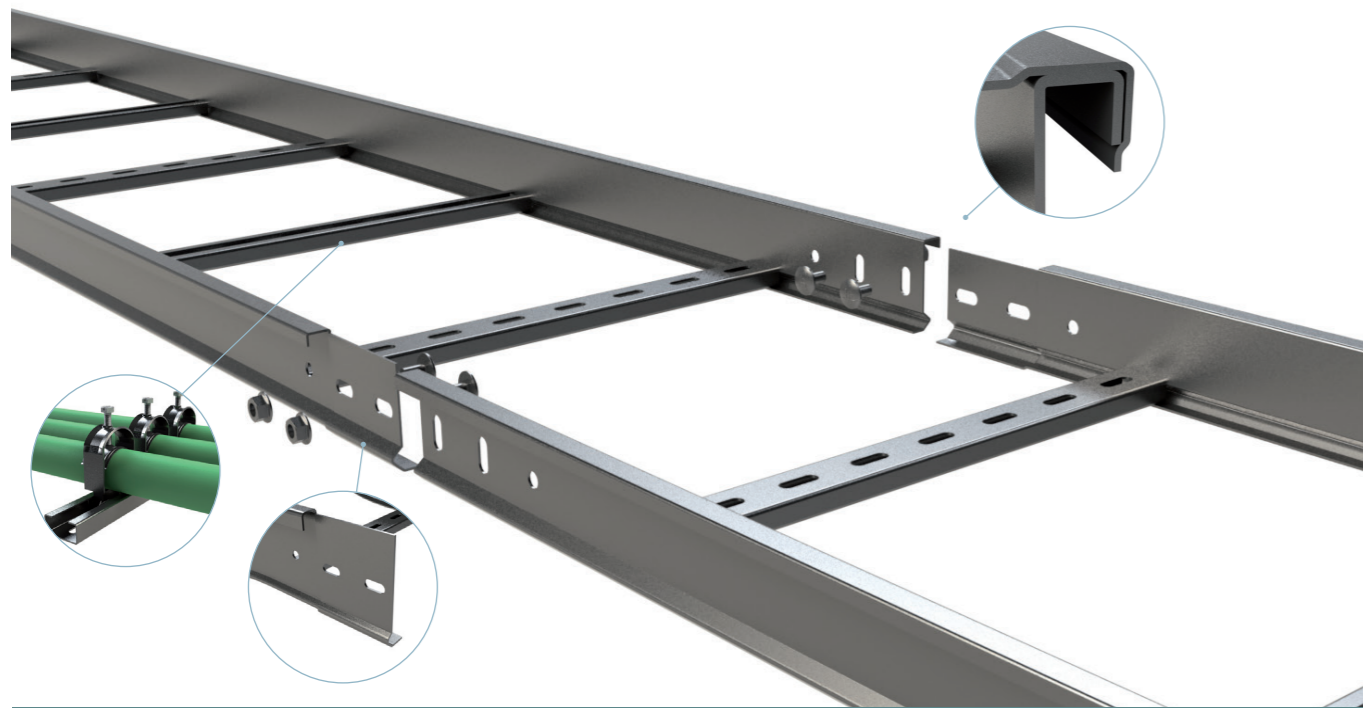

CPFE-300



CCFE-300



CXFE-300



TEFE-300



CRFE-300

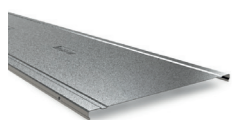

TFE/TFEL

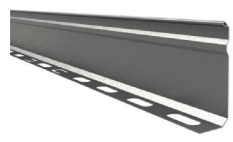

PS

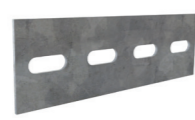

JUFE



JUFE-A



JUFE-B

Filling Area									
B		H75 (3")		H100 (4")		H120 (4 3/4")		H150 (6")	
mm	inch	cm <sup>2</sup>	in <sup>2</sup>	cm <sup>2</sup>	in <sup>2</sup>	cm <sup>2</sup>	in <sup>2</sup>	cm <sup>2</sup>	in <sup>2</sup>
100	4"	59	9,1	84	13,0	-	-	-	-
150	6"	89	13,8	126	19,5	156	24,2	201	31,2
200	8"	118	18,3	168	26,0	208	32,2	268	41,5
300	12"	177	27,4	252	39,1	312	48,4	402	62,3
400	16"	236	36,6	336	52,1	416	64,5	536	83,1
500	20"	295	45,7	420	65,1	520	80,6	670	103,9
600	24"	354	54,9	504	78,1	624	96,7	804	124,6



REFE



BFE



PTFE



B2

## BasorTRAV FE

### FE H75 p333



L = 3 m (10 ft)



### FE H100 p333



L = 3 m (10 ft)

### FE H120 p333



L = 3 m (10 ft)

### FE H150 p333

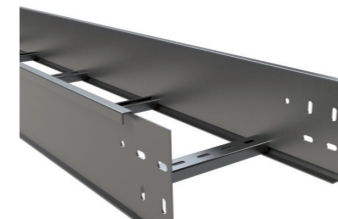

L = 3 m (10 ft)

	B		H		e	HDG	
	mm	inch	mm	inch		REF	MOQ
FE 100x75x2-333 3M	100	4"	75	3"	2	200865	3 M
FE 150x75x2-333 3M	150	6"	75	3"	2	200866	3 M
FE 200x75x2-333 3M	200	8"	75	3"	2	200867	3 M
FE 300x75x2-333 3M	300	12"	75	3"	2	200868	3 M
FE 400x75x2-333 3M	400	16"	75	3"	2	200869	3 M
FE 500x75x2-333 3M	500	20"	75	3"	2	200870	3 M
FE 600x75x2-333 3M	600	24"	75	3"	2	200871	3 M

4/100 x B2 (206792 - HDG)

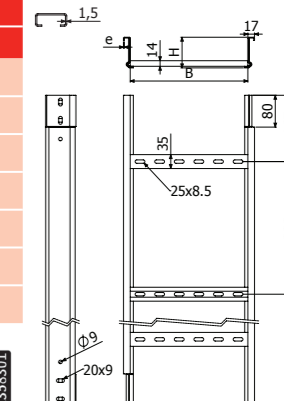

	B		H		e	HDG	
	mm	inch	mm	inch		mm	MOQ
FE 100x100x2-333 3M	100	4"	100	4"	2	200872	3 M
FE 150x100x2-333 3M	150	6"	100	4"	2	200873	3 M
FE 200x100x2-333 3M	200	8"	100	4"	2	200874	3 M
FE 300x100x2-333 3M	300	12"	100	4"	2	200875	3 M
FE 400x100x2-333 3M	400	16"	100	4"	2	200876	3 M
FE 500x100x2-333 3M	500	20"	100	4"	2	200877	3 M
FE 600x100x2-333 3M	600	24"	100	4"	2	200878	3 M

4/100 x B2 (206792 - HDG)

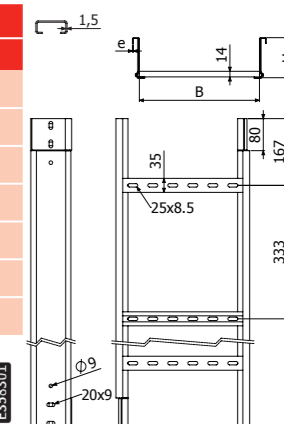

	B		H		e	HDG	
	mm	inch	mm	inch		mm	MOQ
FE 150x120x2-333 3M	150	6"	120	4 3/4"	2	206854	3 M
FE 200x120x2-333 3M	200	8"	120	4 3/4"	2	206855	3 M
FE 300x120x2-333 3M	300	12"	120	4 3/4"	2	206856	3 M
FE 400x120x2-333 3M	400	16"	120	4 3/4"	2	206857	3 M
FE 500x120x2-333 3M	500	20"	120	4 3/4"	2	206858	3 M
FE 600x120x2-333 3M	600	24"	120	4 3/4"	2	206859	3 M

4/100 x B2 (206792 - HDG)

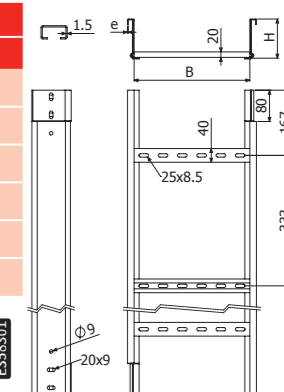

	B		H		e	HDG	
	mm	inch	mm	inch		mm	MOQ
FE 150x150x2-333 3M	150	6"	150	6"	2	206860	3 M
FE 200x150x2-333 3M	200	8"	150	6"	2	206861	3 M
FE 300x150x2-333 3M	300	12"	150	6"	2	206862	3 M
FE 400x150x2-333 3M	400	16"	150	6"	2	206863	3 M
FE 500x150x2-333 3M	500	20"	150	6"	2	206864	3 M
FE 600x150x2-333 3M	600	24"	150	6"	2	206865	3 M

8/100 x B2 (206792 - HDG)

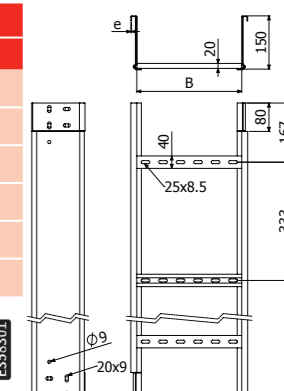



**CRFE-300**



	R		B		H		HDG	
	mm	inch	mm	inch	mm	inch	REF	MOQ
CRFE-300 100X75X2	300	12"	100	4"	75	3"	200951	1 U
CRFE-300 150X75X2	300	12"	150	6"	75	3"	200952	1 U
CRFE-300 200X75X2	300	12"	200	8"	75	3"	200953	1 U
CRFE-300 300X75X2	300	12"	300	12"	75	3"	200954	1 U
CRFE-300 400X75X2	300	12"	400	16"	75	3"	200955	1 U
CRFE-300 500X75X2	300	12"	500	20"	75	3"	200956	1 U
CRFE-300 600X75X2	300	12"	600	24"	75	3"	200957	1 U
CRFE-300 100X100X2	300	12"	100	4"	100	4"	200958	1 U
CRFE-300 150X100X2	300	12"	150	6"	100	4"	200959	1 U
CRFE-300 200X100X2	300	12"	200	8"	100	4"	200960	1 U
CRFE-300 300X100X2	300	12"	300	12"	100	4"	200961	1 U
CRFE-300 400X100X2	300	12"	400	16"	100	4"	200962	1 U
CRFE-300 500X100X2	300	12"	500	20"	100	4"	200963	1 U
CRFE-300 600X100X2	300	12"	600	24"	100	4"	200964	1 U
CRFE-300 150X120X2	300	12"	150	6"	120	4 3/4"	206928	1 U
CRFE-300 200X120X2	300	12"	200	8"	120	4 3/4"	206929	1 U
CRFE-300 300X120X2	300	12"	300	12"	120	4 3/4"	206930	1 U
CRFE-300 400X120X2	300	12"	400	16"	120	4 3/4"	206931	1 U
CRFE-300 500X120X2	300	12"	500	20"	120	4 3/4"	206932	1 U
CRFE-300 600X120X2	300	12"	600	24"	120	4 3/4"	206933	1 U
CRFE-300 150X150X2	300	12"	150	6"	150	6"	206934	1 U
CRFE-300 200X150X2	300	12"	200	8"	150	6"	206935	1 U
CRFE-300 300X150X2	300	12"	300	12"	150	6"	206936	1 U
CRFE-300 400X150X2	300	12"	400	16"	150	6"	206937	1 U
CRFE-300 500X150X2	300	12"	500	20"	150	6"	206938	1 U
CRFE-300 600X150X2	300	12"	600	24"	150	6"	206939	1 U

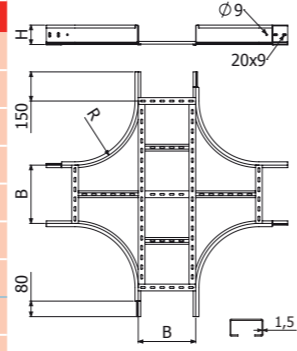

CRFE H75/100/120

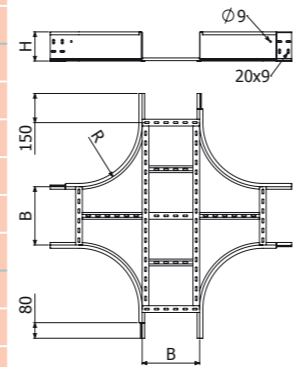

CRFE H150

2 x JUF6 + 4/100 x B2 (206792 - HDG)



**TFE**

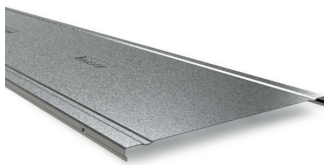

L = 3 m (10 ft)  
400/500/600 - L=2 m (6,56 ft)



	B		e	HDG	
	mm	inch	mm	REF	MOQ
TFE 100x1,5 3M	100	4"	1,5	204937	6 M
TFE 150x1,5 3M	150	6"	1,5	204472	6 M
TFE 200x1,5 3M	200	8"	1,5	204473	6 M
TFE 300x1,5 3M	300	12"	1,5	203579	3 M
TFE 400x1,5 2M	400	16"	1,5	204430	2 M
TFE 500x1,5 2M	500	20"	1,5	204509	2 M
TFE 600x1,5 2M	600	24"	1,5	204494	4 M

4 x PTFE/PTFE-E60 -> 1 x TFE

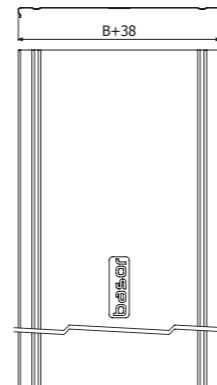

**PTFE**



**PS**

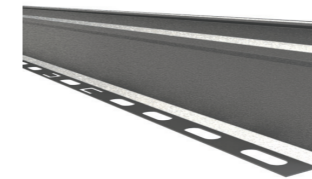

L = 3 m (10 ft)

**BJCFE**



Pap	e	i304	
		REF	MOQ
N-m	mm	207054	30 U

PTFE

10  
4 x PTFE => 1 x TFE

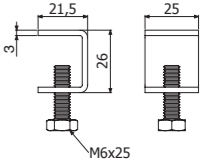

	H		HDG	
	mm	inch	REF	MOQ
PS 35	35	1 3/8"	203479	30 M
PS 60	60	2 3/8"	203480	30 M
PS 80	80	3 1/7"	203481	30 M
PS 100	100	4"	203482	30 M

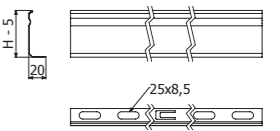

FE H60-100: 3 x (ISO7380-2 M8x30 (218823) + DIN9021 M8 (217543) + DIN934 M8 (217603))  
FE H120-H150 & F2E: 3 x (ISO7380-2 M8x30 (218823) + DIN9021 M10 (218715) + DIN 934 M8 (217603))  
PS 35-> FE H60, PS 60-> FE H75, PS 80->FE H100, PS 100->FE H120/H150.

	e	HDG	
	mm	REF	MOQ
BJCFE 100	1,5	210021	2 U
BJCFE 150	1,5	210022	2 U
BJCFE 200	1,5	210023	2 U
BJCFE 300	1,5	210024	2 U
BJCFE 400	1,5	210025	2 U
BJCFE 500	1,5	210026	2 U
BJCFE 600	1,5	210027	2 U

2/100 x B2 (206792 - HDG)

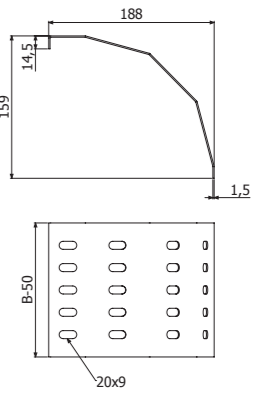

JUFE



	H		e	HDG	
	mm	inch		REF	MOQ
JUFE 60/75	75	3"	2	200854	10 U
JUFE 100	100	4"	2	200856	10 U
JUFE 120	120	4 3/4"	2	206940	10 U
JUFE 150	150	6"	2	206941	10 U

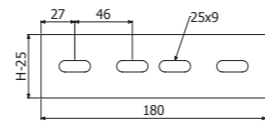

JUFE 75/100/120

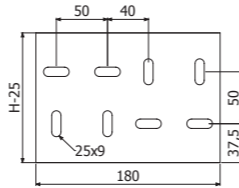

JUFE 150

4/100 x B2 (206792 - HDG) / 8/100 x B2 +150



JUFE-A



	H		e	HDG	
	mm	inch		REF	MOQ
JUFE-A 60/75	75	3"	2	200857	1 U
JUFE-A 100	100	4"	2	200859	1 U
JUFE-A 120	120	4 3/4"	2	206942	1 U
JUFE-A 150	150	6"	2	206943	1 U

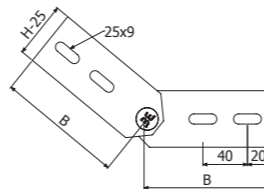

JUFE-A 75/100/120

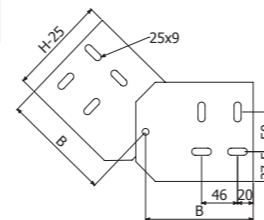

JUFE-A 150

4/100 x B2 (206792 - HDG) / 8/100 x B2 +150



JUFE-B

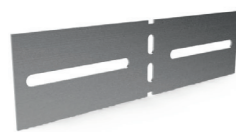
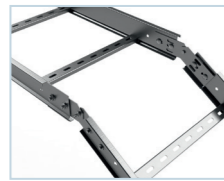

JUFE-B 75-120

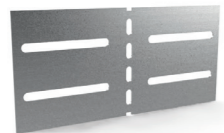

JUFE-B 150

	H		e	HDG	
	mm	inch		REF	MOQ
JUFE-B 60/75	75	3"	2	200860	1 U
JUFE-B 100	100	4"	2	200862	1 U
JUFE-B 120	120	4 3/4"	2	206944	1 U
JUFE-B 150	150	6"	2	206945	1 U

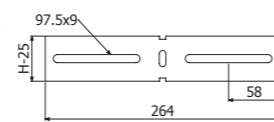

JUFE-B 75/100/120

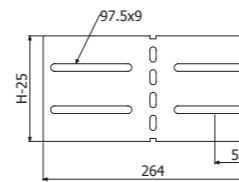

JUFE-B 150

4/100 x B2 (206792 - HDG) / 8/100 x B2 +150



B2



Pap	HDG		i304	
	REF	MOQ	REF	MOQ
B2-100	206792	1 U	205392	1 U

13

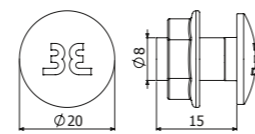

REFE

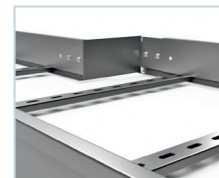

REFE H75/100/120

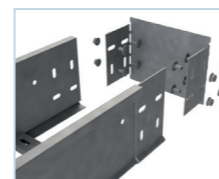

REFE H150

	B		H		e	HDG	
	mm	inch	mm	inch		REF	MOQ
REFE 50x75x2	50	2"	75	3"	2	206803	1 U
REFE 100x75x2	100	4"	75	3"	2	206804	1 U
REFE 150x75x2	150	6"	75	3"	2	206805	1 U
REFE 200x75x2	200	8"	75	3"	2	206806	1 U
REFE 50x100x2	50	2"	100	4"	2	206807	1 U
REFE 100x100x2	100	4"	100	4"	2	206808	1 U
REFE 150x100x2	150	6"	100	4"	2	206809	1 U
REFE 200x100x2	200	8"	100	4"	2	206810	1 U
REFE 50x120x2	50	2"	120	4 3/4"	2	206954	1 U
REFE 100x120x2	100	4"	120	4 3/4"	2	206955	1 U
REFE 150x120x2	150	6"	120	4 3/4"	2	206956	1 U
REFE 200x120x2	200	8"	120	4 3/4"	2	206957	1 U
REFE 50x150x2	50	2"	150	6"	2	206958	1 U
REFE 100x150x2	100	4"	150	6"	2	206959	1 U
REFE 150x150x2	150	6"	150	6"	2	206960	1 U
REFE 200x150x2	200	8"	150	6"	2	206961	1 U

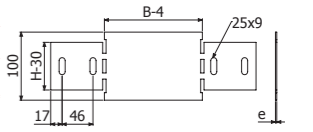

REFE H75/100/120

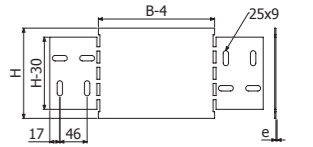

REFE H150

4/100 x B2 (206792 - HDG) / 8/100 x B2 +150

BFE

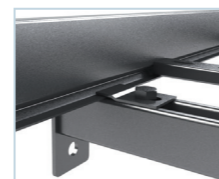
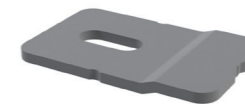

	e	HDG	
		REF	MOQ
BFE 6/8	3	200863	25 U
BFE 10	3	200864	25 U

BFE 6/8 --> SHL --> B2 (206792 - HDG)

SP/SPD + BFE 10 --> DIN933 10X30 (217547- i304) + TM41 M10 (217584 - HDG) + DIN125 M10 (217542-i304)

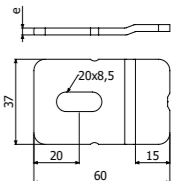

BFE 6/8

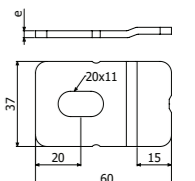

BFE 10

BEV

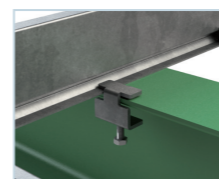

BEV	HDG		i304	
	REF	MOQ	REF	MOQ
BEV	211805	40 U	214473	40 U

10

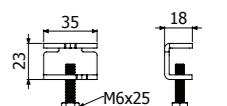



# BasorSUPPORT

CTA kg (lb)		B mm (inch)											
		50 (2")	100 (4")	150 (6")	200 (8")	300 (12")	400 (16")	500 (20")	600 (24")	700 (28")	800 (32")	1000 (40")	
C-SHO		3 6	-	105 (231)	100 (220)	81 (178)	45 (99)	27 (59)	-	-	-	-	-
		9A 9B	-	85 (187)	69 (152)	45 (99)	35 (77)	22 (48)	-	-	-	-	-
SCR		3 6	104 (229)	104 (229)	80 (176)	70 (154)	85 (187)	80 (176)	105 (231)	90 (198)	-	-	-
		9A 9B	-	115 (253)	90 (198)	70 (154)	50 (110)	40 (88)	50 (110)	45 (99)	-	-	-
SRB		3 6	-	70 (155)	60 (133)	60 (133)	60 (133)	60 (133)	60 (133)	60 (133)	60 (133)	-	-
SRB-N		3	-	160 (352)	165 (363)	140 (308)	135 (397)	120 (264)	-	-	-	-	-
SHL		6 9C 9D	-	205 (450)	205 (450)	205 (450)	250 (550)	250 (550)	250 (550)	250 (550)	-	-	-
SHR		6 9C 9D	-	-	-	-	480 (1058)	365 (804)	300 (661)	285 (628)	270 (595)	265 (584)	-
SP		6	-	350 (772)	350 (772)	350 (772)	290 (640)	250 (552)	220 (486)	200 (441)	-	-	-
		9C 9D	-	525 (1157)	444 (979)	342 (754)	292 (643)	250 (551)	231 (509)	213 (469)	-	-	-
SPD		6	-	-	-	-	-	500 (1103)	500 (1103)	430 (948)	370 (816)	320 (706)	260 (574)
		9C 9D	-	-	-	-	-	-	610 (1344)	610 (1344)	520 (1146)	450 (992)	390 (859)
SP8		6	-	-	-	-	-	600 (1322)	600 (1322)	600 (1322)	540 (1190)	464 (1022)	305 (672)
SP+R450		6	-	-	-	-	-	724 (1597)	592 (1306)	501 (1105)	434 (957)	383 (845)	310 (684)
SPD+R450		6	-	-	-	-	-	-	1123 (2476)	950 (2095)	823 (1815)	726 (1601)	588 (1297)
SHST		3	-	160 (352)	160 (352)	146 (321)	157 (346)	124 (273)	111 (244)	106 (233)	-	-	-
SVP+SP		6	-	-	350 (772)	350 (772)	290 (640)	250 (552)	220 (486)	200 (441)	-	-	-
I8+SHV		7	-	-	-	-	200 (441)	200 (441)	200 (441)	200 (441)	200 (441)	200 (441)	-
KS+SCR/SRB		3 6	-	260 (573)	240 (528)	195 (429)	120 (264)	74 (169)	145 (319)	105 (231)	-	-	-
KSR+C-SR		3 6 9A 9B	-	-	-	195 (429)	85 (187)	175 (385)	135 (297)	110 (242)	-	-	-







CTA kg (lb)

	B mm (inch)										
	50 (2")	100 (4")	150 (6")	200 (8")	300 (12")	400 (16")	500 (20")	600 (24")	700 (28")	800 (32")	1000 (40")
C-SHOT											
C-SVO + 2 VR8											
C-SHO 400											
SU											
SUR											
SU + R450											
SUR + R450											
SP3S											
SP											
SP + R450											
SPD											
SPD + R450											

C-SHOT



	B		CTA		e	PG		HDG		e	i304	
	mm	inch	kg	lb		REF	MOQ	REF	MOQ		mm	REF
C-SHOT100	100	4"	105	232	1,5	207235	6 U	207244	6 U	1,5	207495	6 U
C-SHOT150	150	6"	75	166	2	207236	6 U	207245	6 U	1,5	207496	6 U
C-SHOT200	200	8"	70	155	2	207237	4 U	207246	4 U	1,5	207497	4 U
C-SHOT300	300	12"	37	82	2	207238	4 U	207247	4 U	1,5	207498	4 U
PSHO	-	-	-	-	2	206240	40 U	206318	40 U	-	-	-
TFSO(2/0894)												

- 1 PSHO ( 206240-PG / 206318-HDG / 218139-I304 )
- B1 ( 204356-EZ / 206826-HDG / 204925-I304 )
- TFSO

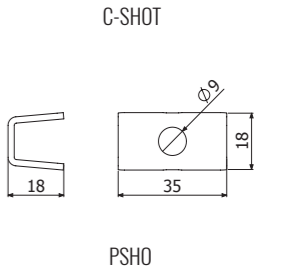
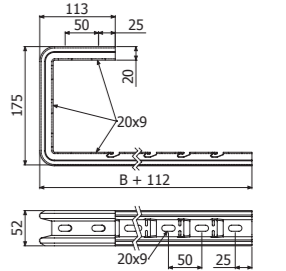

C-SVO



	B		e	CTA		PG		HDG		e	i304	
	mm	inch		mm	kg	lb	REF	MOQ	REF		MOQ	mm
C-SVO100	100	4"	1,5	250	552	203630	16 U	206280	16 U	1,5	206285	1 U
C-SVO150	150	6"	1,5	200	441	201073	16 U	201078	1 U	1,5	201087	1 U
C-SVO200	200	8"	2	294	649	201074	12 U	201079	12 U	1,5	201088	1 U
C-SVO300	300	12"	2	235	519	201076	12 U	201081	12 U	1,5	201090	1 U
C-SVO400	400	16"	2	161	355	203629	6 U	205719	6 U	1,5	206286	6 U
C-SVO500	500	20"	2	115	254	201077	6 U	201082	6 U	1,5	206287	6 U
C-SVO600	600	24"	2	87	192	205941	6 U	205720	6 U	1,5	206288	6 U
C-SVO 3000	-	-	-	-	-	201101	24 M	207436	3 M	-	-	-
TFSO(2/0894)												

- 2 x DIN976 M8x1000 ( 203397-EZ / 206852-i304 ) + 4 x DIN6923 M8 ( 217553-EZ / 217555-i304 )
- B1 ( 204356-EZ / 206826-HDG / 204925-I304 )

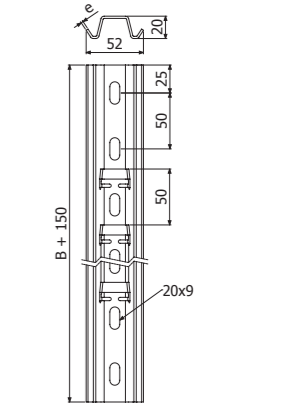

C-SHO



	L	e	Fmáx		Cd	PG		HDG		Fmáx		Cd	i304		
			kg	kg-m		mm/kg-m	REF	MOQ	REF	MOQ	kg		kg-m	mm/kg-m	REF
C-SHO400	400	16"	2	200	5,4	3,05	207234	12 U	207243	12 U	185	4,4	5,8	207494	12 U
C-SHO400 - C-SHO100	400	16"	2	341	8,8	2,35	-	-	-	-	318	7,3	3,5	-	-
PSHO	-	-	2	-	-	-	206240	40 U	206318	40 U	-	-	-	-	-

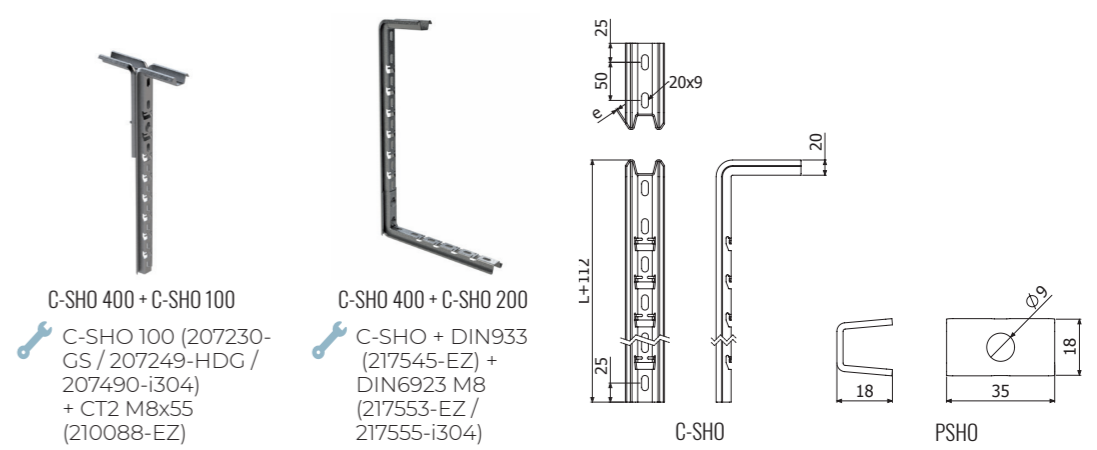

SU



	L		e	ep	Fmáx	Mmáx	Cd	HDG		i304 - i316
	mm	inch						REF	MOQ	
SU400	400	16"	2,5	6	656	51,55	0,191	207142	2 U	
SU600	600	24"	2,5	6	656	51,55	0,287	207143	2 U	
SU800	800	32"	2,5	6	656	51,55	0,398	207144	2 U	

TFSU PVC ( 2/12114)

SCR / SRB / SHL / SHR + 2/100 x B2 (206792-HDG)

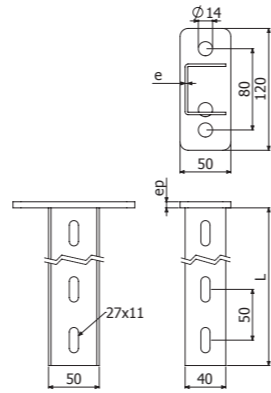

SUR



	L		e	ep	Fmáx	Mmáx	Cd	HDG70	
	mm	inch						REF	MOQ
SUR600	600	24"	4	8	1100	145	0,08	207487	1 U
SUR800	800	32"	4	8	1100	145	0,131	207488	1 U
SUR1000	1000	40"	4	8	1100	145	0,204	207489	1 U

TFSUR PVC (2/14254)

SHL / SHR / SP / SPD +2/50xB3 (2/8827-HDG / 212096-i304)

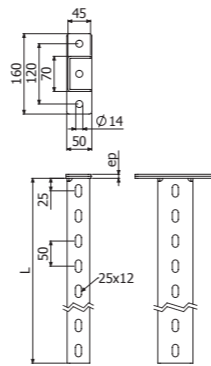

SP



	L		e	ep	Fmáx	Mmáx	Cd	HDG	
	mm	inch						REF	MOQ
SP300	300	12"	2,5	4	725	55,15	0,142	204734	1 U
SP400	400	16"	2,5	4	725	55,15	0,203	201036	1 U
SP500	500	20"	2,5	4	725	55,15	0,265	201037	1 U
SP600	600	24"	2,5	6	725	55,15	0,326	204938	1 U
SP800	800	32"	2,5	6	725	55,15	0,509	201038	1 U

TF41 PVC ( 2/5627)

SCR/SRB/SRB-N (PG) + 2 x TEP M10x30 ( 217567-EZ)  
SCR/SRB/SRB-N + 2 x TM41 M8 ( 217583-HDG / 218524-i304 ) + 2 x DIN933 M8x30 ( 205964-i304 ) + 2 x DIN125 M8 ( 217544-i304 ) + 2 x 4182K ( 218515-HDG / 218758-i304 )  
SHL/SHR/SP + 2 x DIN933 M10x30 ( 217547-i304 ) + 2 x TM41 M10 ( 217584-HDG / 218525-i304 ) + 2 x DIN125 M10 (217542-i304)

SCR/SRB + 2/100 x B2(206792-HDG / 205392-i304)

SHL + 2/50 x B3(208827-HDG / 2012096-i304)

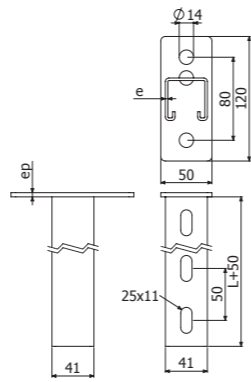

SP



TF41

SPD



	L		e	ep	Fmáx	Mmáx	Cd	HDG	
	mm	inch						REF	MOQ
SPD 500	500	20"	2,5	8	1100	133	0,147	206272	1 U
SPD 600	600	24"	2,5	8	1100	133	0,179	205621	1 U
SPD 700	700	28"	2,5	8	1100	133	0,211	206273	1 U
SPD 800	800	32"	2,5	8	1100	133	0,263	206274	1 U
SPD 1000	1000	40"	2,5	8	1100	133	0,316	204641	1 U

TF41 PVC ( 2/5627)

SCR/SRB/SRB-N (PG) + 2 x TEP M10x30 ( 217567-EZ)  
SCR/SRB/SRB-N + 2 x TM41 M8 ( 217583-HDG / 218524-i304 ) + 2 x DIN933 M8x30 ( 25964-i304 ) + 2 x DIN125 M8 ( 217544-i304 ) + 2 x 4182K ( 218515-HDG / 218758-i304 )

SHL/SHR/SP/SPD + 2 x DIN933 M10x30 ( 217547-i304 ) + 2 x TM41 M10 ( 217584-HDG / 218525-i304 ) + 2 x DIN125 M10 (217542-i304)

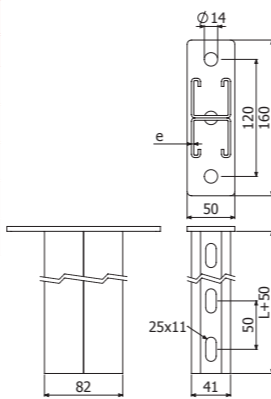

SPD



TF41

SP3S



	L		e	ep	Fmáx	Mmáx	Cd	EZ		HDG	
	mm	inch						REF	MOQ	REF	MOQ
SP3S 400	400	16"	2	4	800	34,5	0,195	218658	1 U	217308	1 U
SP3S 500	500	20"	2	4	800	34,5	-	218659	1 U	217309	1 U
SP3S 600	600	24"	2	6	800	34,5	0,325	218660	1 U	217310	1 U
SP3S 800	800	32"	2	6	800	34,5	0,514	218661	1 U	217311	1 U
SP3S 1000	1000	40"	2	6	800	34,5	0,811	218662	1 U	-	-
SP3S 1200	1200	48"	2	6	800	34,5	-	218663	1 U	-	-

TF41 PVC ( 2/5627)

DIN933 M10x65 EZ + DIN934 M10 (217607-EZ / 217602-i304)  
SHST



TF41

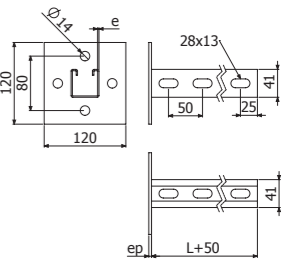

SHST



CLICK

	L		e	CTA		PG	
	mm	inch		kg	lb	REF	MOQ
SHST100	100	4"	1,5	160	352	214489	4 U
SHST150	150	6"	1,5	160	352	214490	4 U
SHST200	200	8"	1,5	146	321	214491	4 U
SHST300	300	12"	2	157	346	214492	4 U
SHST400	400	16"	2	124	273	214493	4 U
SHST500	500	20"	2	111	244	214494	4 U
SHST600	600	24"	2	106	233	214495	4 U

B1 ( 204356-EZ)

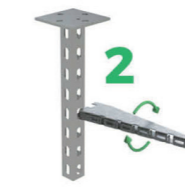
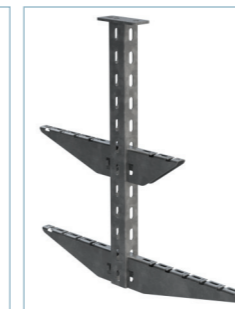
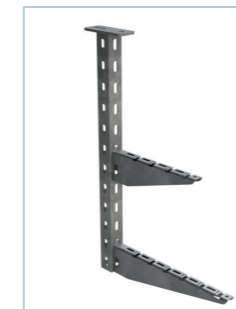
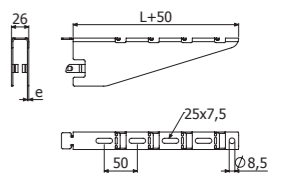

CTA kg (lb)



	B mm (inch)							
	100 (4")	150 (6")	200 (8")	300 (12")	400 (16")	500 (20")	600 (24")	
SV	 3 6 9A 9B	276 (609)	260 (573)	253 (558)	207 (456)	506 (1116)	460 (1014)	414 (912)
PBF	 3 6 9A 9B	250 (551) x 1	250 (551) x 1	250 (551) x 1	250 (551) x 2	250 (551) x 2	250 (551) x 2	250 (551) x 3
SFS+C-SVO	 3 6	176 (388)	176 (388)	176 (388)	176 (388)	161 (354)	115 (253)	87 (191)
SP	 6	470 (1037)	400 (882)	347 (766)	275 (607)	228 (503)	195 (430)	170 (375)
SU	 6 9A 9B	431 (951)	368 (812)	321 (708)	255 (563)	212 (468)	182 (402)	160 (353)
SPD	 6	837 (1846)	748 (1650)	675 (1489)	566 (1248)	487 (1074)	428 (944)	381 (840)

SV



SV 100/150/200/300



SV 400/500/600

PBF

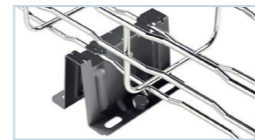
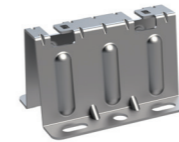

SFS + C-SVO



C-SVO



SFS



2 x SFS + C-SVO + 2/100 x B1



TFSSO

	B		e	CTA		PG		HDG		i304	
	mm	inch		mm	kg	lb	REF	MOQ	REF	MOQ	REF
SV100	100	4"	1,5	276	609	201046	10 U	201050	10 U	201062	10 U
SV150	150	6"	1,5	260	573	201047	6 U	201051	6 U	201063	6 U
SV200	200	8"	1,5	253	558	201048	6 U	201052	6 U	201064	6 U
SV300	300	12"	1,5	207	456	201049	6 U	201053	6 U	201065	6 U
SV400	400	16"	1,5	506	1116	203413	5 U	203418	5 U	-	-
SV500	500	20"	1,5	460	1014	203414	5 U	203419	5 U	-	-
SV600	600	24"	1,5	414	912	203415	5 U	203420	5 U	-	-

B1 ( 204356-EZ / 206826-HDG / 204925-i304 )  
 CTBF ( 204362-EZ / 207132-HDG / 204923-i304 )

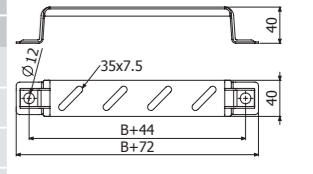

SV 100/150/200/300

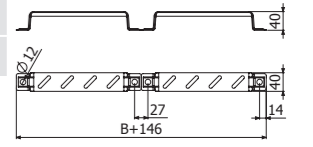

SV 400/500/600

	e	CTA		PG		HDG		i304	
		mm	kg	lb	REF	MOQ	REF	MOQ	REF
PBF	1	250	551	205590	12 U	204397	27 U	208777	12 U

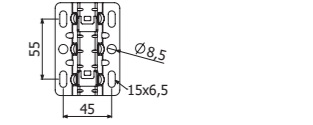
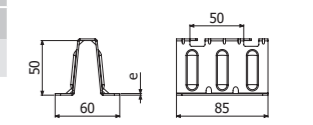

	B		e	CTA		PG		HDG		e	i304	
	mm	inch		mm	kg	lb	REF	MOQ	REF		MOQ	mm
C-SVO 100	100	4"	1,5	176	388	203630	16 U	206280	16 U	1,5	206285	1 U
C-SVO 150	150	6"	1,5	176	388	201073	16 U	201078	1 U	1,5	201087	1 U
C-SVO 200	200	8"	2	176	388	201074	12 U	201079	12 U	1,5	201088	1 U
C-SVO 300	300	12"	2	176	388	201076	12 U	201081	12 U	1,5	201090	1 U
C-SVO 400	400	16"	2	161	354	203629	6 U	205719	6 U	1,5	206286	6 U
C-SVO 500	500	20"	2	115	253	201077	6 U	201082	6 U	1,5	206287	6 U
C-SVO 600	600	24"	2	87	192	205941	6 U	205720	6 U	1,5	206288	6 U
SFS 140 GS	-	-	2	-	-	205602	24 U	-	-	-	-	-

TFSSO (2/0894)

	B		e	CTA		PG		HDG		e	i304	
	mm	inch		mm	kg	lb	REF	MOQ	REF		MOQ	mm
C-SVO 3M	-	-	-	-	-	201101	-	207436	-	-	-	-

2/100 x B1 ( 204356 EZ / 206826 HDG / 204925-i304 )

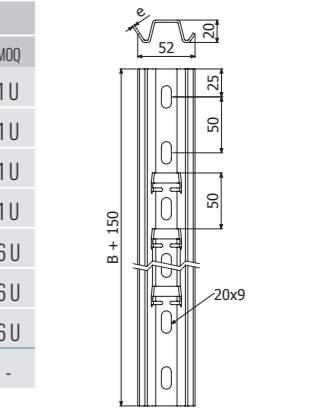

C-SVO

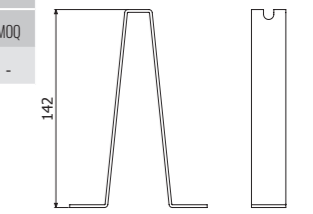

SFS

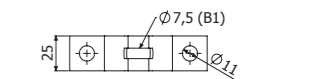

SOLUTIONS / SOLUÇÕES / ŘEŠENÍ / LÖSUNGEN

CT30 / KCT30 PG



C-PC / KPC / KLPC PG

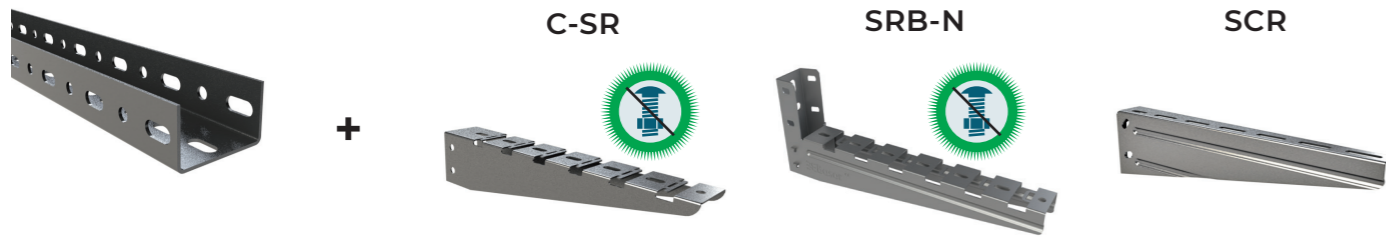

PC / KAPC HDG

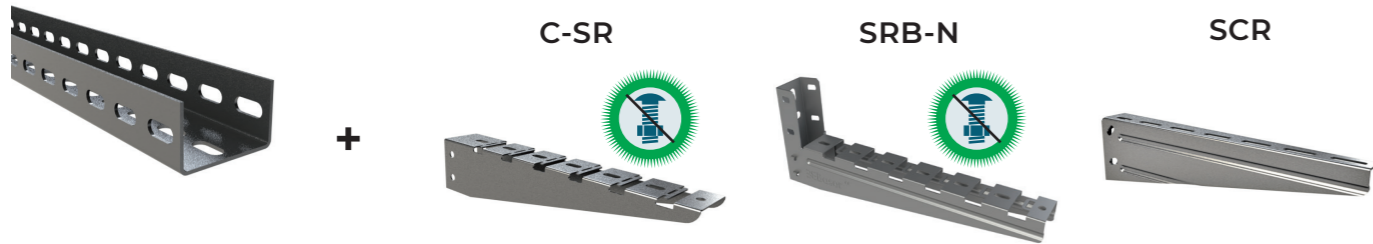

P41-3S PG

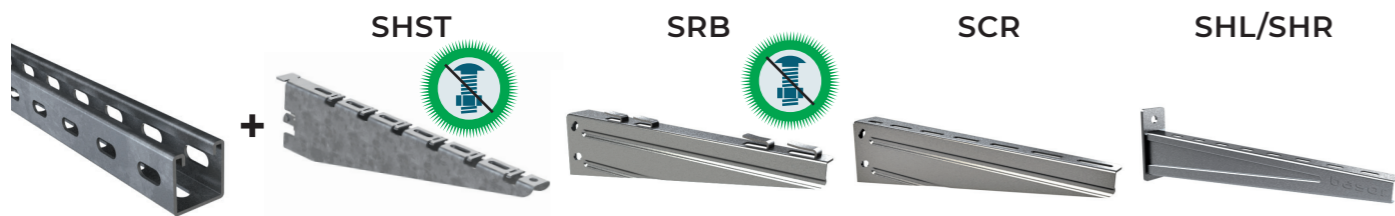

I8 HDG



CT30 / KCT30

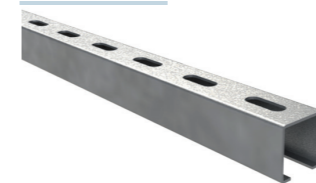

CT30



KCT30



KCT30+CT30+CT2



CT4 M10x20 17



CT2 M8x75 13

	Fmáx	Mmáx	PG	
	ud	kg	REF	MOQ
CT30	-	-	206784	24 M
KCT30	500	19,5	207071	10 U
CT4-100 M10X20 EZ	-	-	207074	1 U
CT2 M8X75 EZ	-	-	206793	100 U

SCR/SRB/SRB-N (PG) --> 2/100 x CT4 (207074-EZ)  
 CT30 + KCT30--> 2x CT2 M8X75 (206793 - EZ) (214307-i304)  
 + 2 x DIN125 M8 (217544-i304)

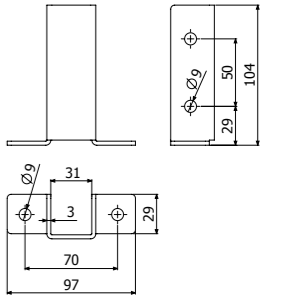

KCT30

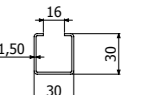

CT30

SCR

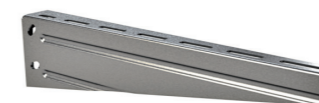

	B	e	CTA	PG		HDG		e	CTA	i304				
				REF	MOQ	REF	MOQ			mm	kg	lb	REF	MOQ
SCR 50	50	2"	1,5	104	229	200975	10 U	203450	10 U	-	-	-	-	
SCR 100	100	4"	1,5	104	229	200976	10 U	200980	10 U	1,5	115	253	200995	10 U
SCR 150	150	6"	1,5	80	176	200977	10 U	200981	10 U	1,5	90	198	200996	10 U
SCR 200	200	8"	1,5	70	154	200978	10 U	200982	10 U	1,5	70	154	204691	1 U
SCR 300	300	12"	2	85	187	200997	10 U	201002	1 U	1,5	50	110	201020	10 U
SCR 400	400	16"	2	80	176	200998	10 U	201003	1 U	1,5	40	88	201021	10 U
SCR 500	500	20"	2	105	231	200999	10 U	201004	1 U	1,5	50	110	204464	10 U
SCR 600	600	24"	2	90	198	201000	10 U	201005	1 U	1,5	45	99	201022	10 U

B1 (204356-EZ / 206826-HDG / 204925-i304)

CTBF (204362-EZ / 207132-HDG / 204923-i304)

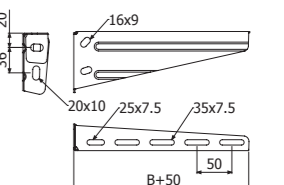

SCR 50/100/200/300/400

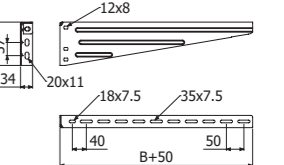

SCR 500/600/750

SRB

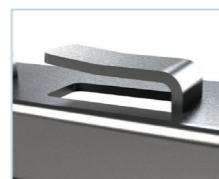

	B	e	CTA	PG		HDG				
				REF	MOQ	REF	MOQ			
SRB 100	2	100	4"	1,5	70	155	206372	5 U	206379	1 U
SRB 150	2	150	6"	1,5	60	133	206373	5 U	206380	1 U
SRB 200	3	200	8"	1,5	60	133	206374	5 U	206381	1 U
SRB 300	4	300	12"	2	60	133	206375	5 U	206382	1 U
SRB 400	4	400	16"	2	60	133	206376	5 U	206383	1 U
SRB 500	4	500	20"	2	60	133	206377	5 U	206384	1 U
SRB 600	4	600	24"	2	60	133	206378	5 U	206385	1 U

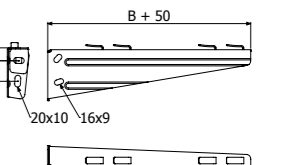

SRB 100/150/200/300/400

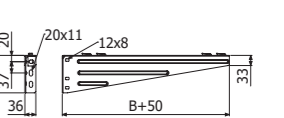

SRB 500/600







P41-3S 41X41X2 3M



L = 3 m (10 ft)

P41-3S 41X41X2 3M	e	PG	
		REF	MOQ
	2	217313	3 M

	Qreac	Pap	e	PG		e	HDG	
				REF	MOQ		REF	MOQ
SBL41-3S	600	40	3	218657	1 U	4	2/6472	1 U
CT2 M8x75 EZ	-	-	-	206793	100 U	-	-	-
K41-3S (EZ)	-	-	-	218656	2 U	-	-	-

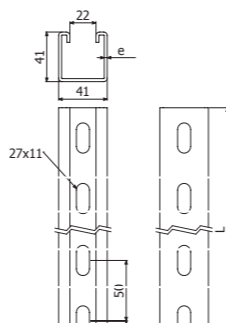

SBL41-3S K41-3S



CT2 M8x75

- SHST
- SCR/SRB + 2/100 x B2(206792-HDG / 205392-i304)  
SHL + 2/50 x B3(208827-HDG / 212096-i304)
- SCR/SRB/SRB-N (PG) + 2 x TEP M10x30 (217567-EZ)  
SCR/SRB/SRB-N + 2 x TM41 M8 (217583-HDG / 218524-i304) + 2 x DIN933 M8x30 (205964-i304) + 2 x DIN125 M8 (217544-i304) + 2 x 4182K (218515-HDG / 218758-i304)  
SHL/SHR + 2 x DIN933 M10x30 (217547-i304) + 2 x TM41 M10 (217584-HDG / 218525-i304) + 2 x DIN125 M10 (217542-i304)

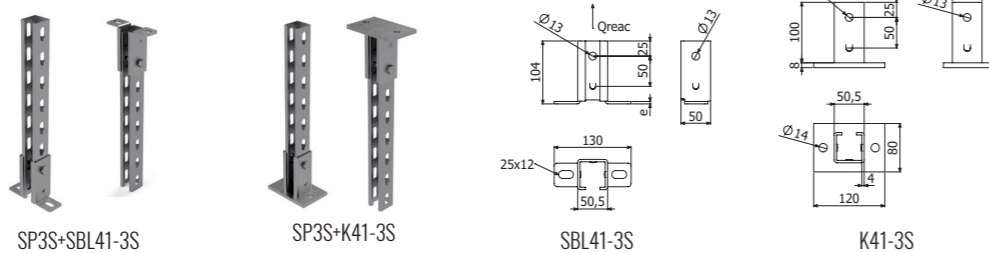

SP3S+SBL41-3S SP3S+K41-3S SBL41-3S K41-3S

SHL



	B		e	ep	H		CTA		HDG		i
	mm	inch			mm	mm	mm	inch	kg	lb	
SHL 100	100	4"	1.5	4	47	1 7/8"	205	450	206866	8 U	3
SHL 150	150	6"	1.5	4	53	2"	205	450	206867	4 U	0
SHL 200	200	8"	1.5	4	58	2 1/4"	205	450	206868	4 U	-
SHL 300	300	12"	1.5	6	68	2 3/4"	250	550	206869	2 U	3
SHL 400	400	16"	1.5	6	79	3 1/8"	250	550	206870	2 U	1
SHL 500	500	20"	2	6	89	3 1/2"	250	550	206871	2 U	6
SHL 600	600	24"	2	6	100	4"	250	550	206872	2 U	6

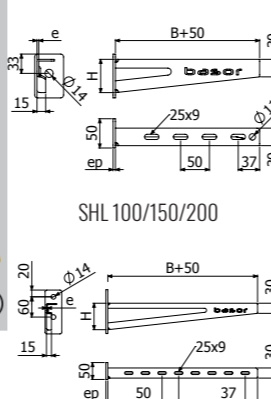

- B1 (204356-EZ / 206826-HDG)
- CTBF (204362-EZ / 207132-HDG)
- BFE (200863-HDG) + B2 (206792-HDG)

SHL 100/150/200  
SHL 300/400/500/600

SHR



	B		e	ep	H		CTA		HDG		i
	mm	inch			mm	mm	mm	inch	kg	lb	
SHR 300	300	12"	2.5	6	68	2 3/4"	480	1058	205525	1 U	3
SHR 400	400	16"	2.5	6	79	3 1/8"	365	804	201023	1 U	0
SHR 500	500	20"	2.5	6	89	3 1/2"	300	661	201024	1 U	-
SHR 600	600	24"	2.5	6	100	4"	285	628	201025	1 U	3
SHR 700	700	28"	2.5	6	110	4 3/8"	270	595	201026	1 U	1
SHR 800	800	32"	2.5	6	120	4 3/4"	265	584	201027	1 U	6

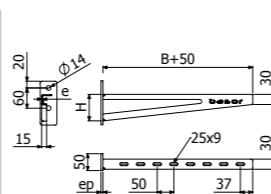

- B1 (204356-EZ / 206826-HDG)
- CTBF (204362-EZ / 207132-HDG)
- BFE (200863-HDG) + B2 (206792-HDG)

I8 3M



I8



KI8 KAI8 TF18

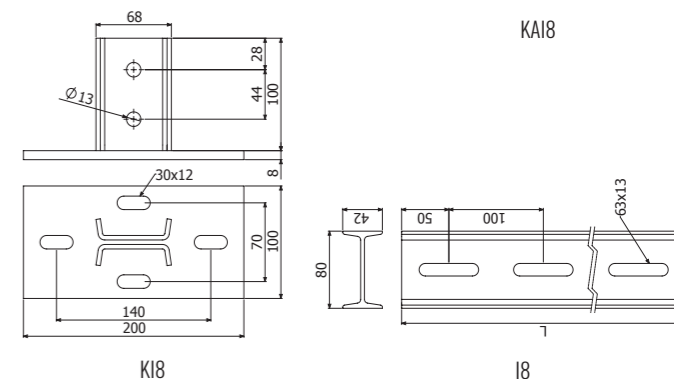

	L		HDG70	
	m	ft	REF.	MOQ
	I8 3M	3	10	206350
KI8	-	-	206056	1 U
KAI8	-	-	207052	1 U
TF18 PVC (2/6947)	-	-	-	-

- I8 +KI8 --> 2/100 x CT1 M10X30 (206320-i304) + 2 x DIN125 M10 (217542-i304)
- I8 +KAI8 --> 4/100 x CT1 M10X30 (206320-i304) + 8 x DIN125 M10 (217542-i304)

SHV

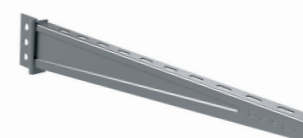

	B		e	ep	HDG		i
	mm	inch			REF.	MOQ	
SHV 200	200	8"	2.5	3	206058	2 U	3
SHV 300	300	12"	2.5	3	206271	2 U	0
SHV 400	400	16"	2.5	3	206259	2 U	-
SHV 500	500	20"	2.5	3	206057	2 U	3
SHV 600	600	24"	2.5	3	206275	2 U	1
SHV 700	700	28"	2.5	3	206276	2 U	6
SHV 800	800	32"	2.5	3	206277	2 U	6

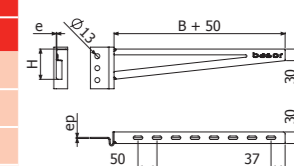

- B1 (204356-EZ / 206826-HDG)
- CTBF (204362-EZ / 207132-HDG)
- BFE (200863-HDG) + B2 (206792-HDG)

BI8 + I8 + SHV

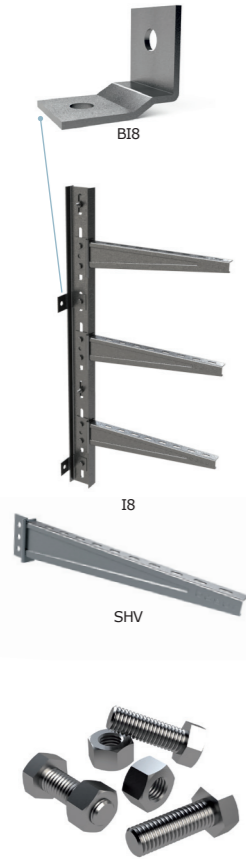

	L		B		BRD P		e		ep		H		CTA		HDG	
	mm	inch	n	mm	mm	mm	inch	kg	lb	REF	MOQ					
I8 600	600	24"	3	-	-	-	-	-	-	206345	1 U					
I8 1000	1000	39"	3	-	-	-	-	-	-	206346	1 U					
I8 1300	1300	51"	4	-	-	-	-	-	-	206347	1 U					
I8 1500	1500	59"	5	-	-	-	-	-	-	206348	1 U					
I8 2000	2000	79"	6	-	-	-	-	-	-	206349	1 U					
I8 3M	3000	118"	8	-	-	-	-	-	-	206350	1 U					
SHV 200	200	8"	-	2,5	3	58	2 1/4"	200	441	206058	2 U					
SHV 300	300	12"	-	2,5	3	68	2 5/8"	200	441	206271	2 U					
SHV 400	400	16"	-	2,5	3	79	3 1/8"	200	441	206259	2 U					
SHV 500	500	20"	-	2,5	3	89	3 1/2"	200	441	206057	2 U					
SHV 600	600	24"	-	2,5	3	100	4"	200	441	206275	2 U					
SHV 700	700	28"	-	2,5	3	110	4 3/8"	200	441	206276	2 U					
SHV 800	800	32"	-	2,5	3	120	4 3/4"	200	441	206277	2 U					
BI8	-	-	-	-	-	-	-	-	-	206342	10 U					
PACK 100 CT1 M10x30 (i304)	-	-	-	-	-	-	-	-	-	206320	1 U					

SHV → I8: 2/100 x CT1 M10x30 (206320 i304) + 2 x DIN125 M10 (217542 -i304)

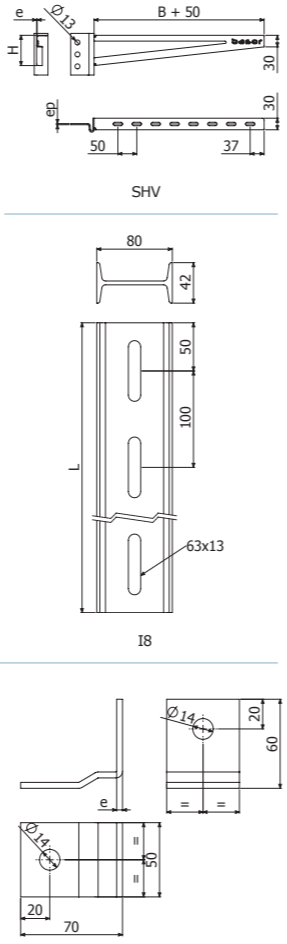
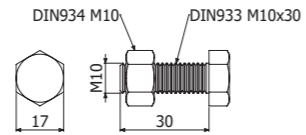

C-SHO 400 + C-SHO	KCT30+CT30+SCR	KCT30+CT30+2XSCR	SP3S+SHST
KPC+C-PC+C-SR	KLPC+C-PC+2xSCR	KAPC+C-PC+2xC-SR	SP+SP
SPD+SHR	KI8+I8+SHV	BRP+P41 41x21+SPD+SHR	SZ+SCR
SU+SCR	SU+SHL	KPC+2xC-PC+4xSRB-N	BI8+I8+SHV
C-SVO+VR8	SP+P41 41x41+4182C	SPD+SCR	KI8+I8+SHV+TFI8
SPD+P41 41x41+4182D	SPD+K82+SHR	KI8+I8+SHV	PC+KAPC+C-SR



# BasorPLAST

## BasorPLAST BPE

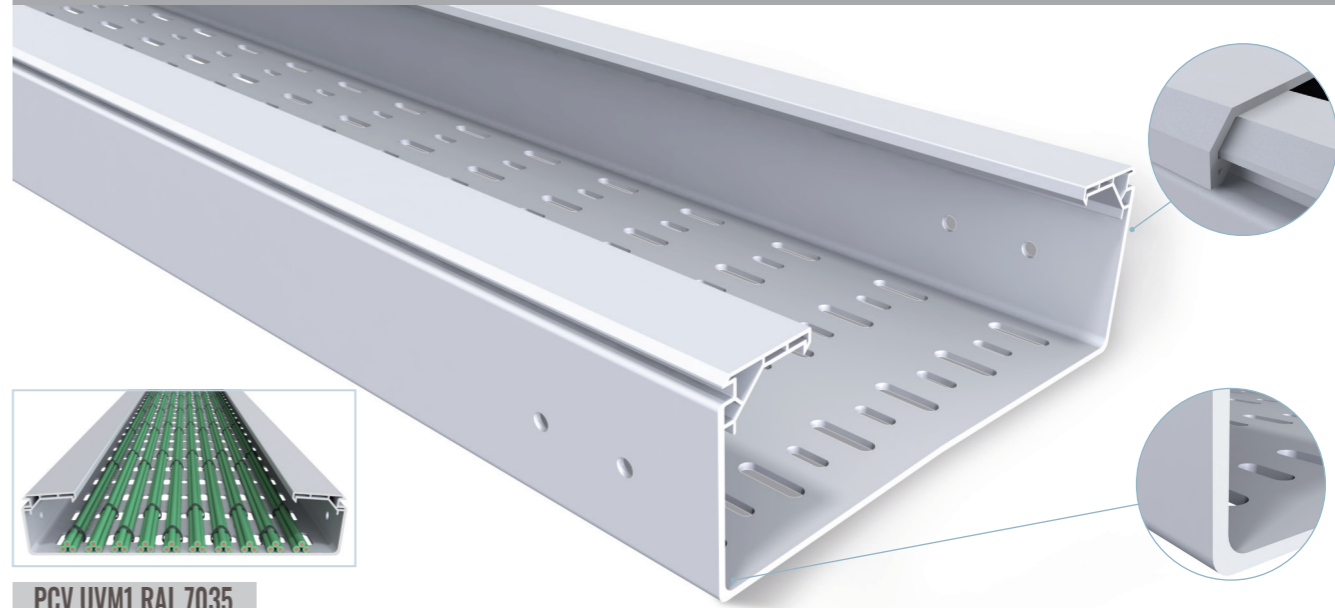

PCV UVM1 RAL 7035

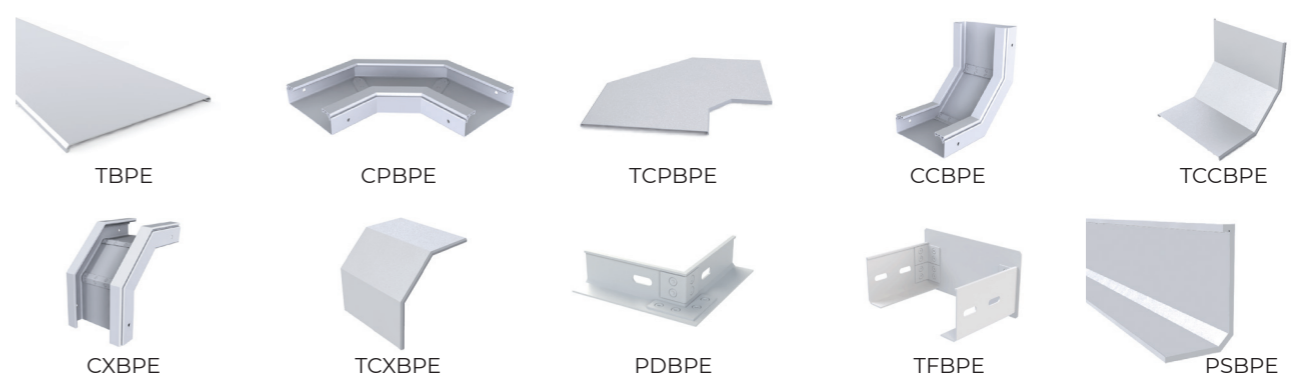
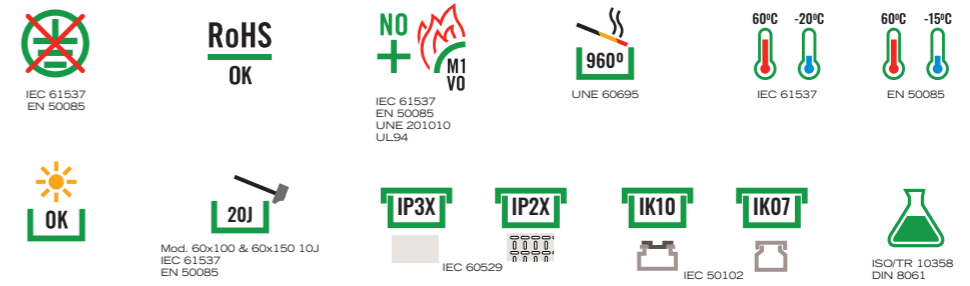

- TBPE
- CPBPE
- TCPBPE
- CCBPE
- TCCBPE
- CXBPE
- TCXBPE
- PDBPE
- TFBPE
- PSBPE
- JUBPE
- JUBPE-A
- JUBPE-B
- JUBPE-C
- BIK10-BPE
- CTBP

B		Filling Area			
		H60 (2 3/8")		H100 (4")	
mm	inch	cm <sup>2</sup>	in <sup>2</sup>	cm <sup>2</sup>	in <sup>2</sup>
100	4"	52	8,06	-	-
150	6"	80	12,4	-	-
200	8"	101	15,7	175	27,1
300	12"	152	23,6	263	40,8
400	16"	-	-	354	54,8
600	24"	-	-	539	83,5



**TCCBPE**



	B		UVM1 7035	
	mm	inch	REF	MOQ
TCCBPE 60X100	100	4"	210111	1 U
TCCBPE 60X150	150	6"	210112	1 U
TCCBPE 60X200	200	8"	210113	1 U
TCCBPE 60X300	300	12"	210114	1 U
TCCBPE 100X200	200	8"	210115	1 U
TCCBPE 100X300	300	12"	210116	1 U
TCCBPE 100X400	400	16"	210117	1 U
TCCBPE 100X600	600	24"	210118	1 U

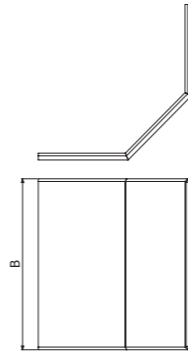

TCCBPE B100-400 TCCBPE 600

**CXBPE**



	H		B		C		R		UVM1 7035	
	mm	inch	mm	inch	mm	inch	mm	inch	REF	MOQ
CXBPE 60X100	60	2 3/8"	100	4"	240	9 1/2"	100	4"	210119	2 U
CXBPE 60X150	60	2 3/8"	150	6"	240	9 1/2"	100	4"	210120	2 U
CXBPE 60X200	60	2 3/8"	200	8"	240	9 1/2"	100	4"	210121	2 U
CXBPE 60X300	60	2 3/8"	300	12"	240	9 1/2"	100	4"	210122	2 U
CXBPE 100X200	100	4"	200	8"	275	11"	115	4 5/8"	210123	2 U
CXBPE 100X300	100	4"	300	12"	275	11"	115	4 5/8"	210124	2 U
CXBPE 100X400	100	4"	400	16"	275	11"	115	4 5/8"	210125	1 U
CXBPE 100X600	100	4"	600	24"	275	11"	115	4 5/8"	210126	2 U

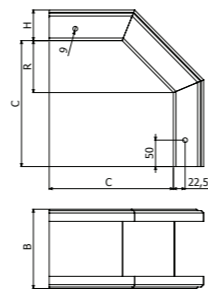

H60

2 x JUBPE 60 (210084) + 4/100 CTPB (210017)  
 2 x JUBPE 100 (210085) + 8/100 CTPB (210017)

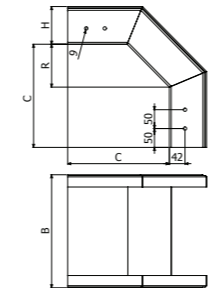

H100

**TCXBPE**

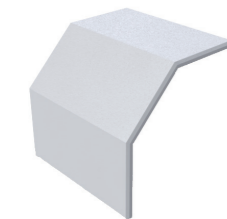

	B		UVM1 7035	
	mm	inch	REF	MOQ
TCXBPE 60X100	100	4"	210127	1 U
TCXBPE 60X150	150	6"	210128	1 U
TCXBPE 60X200	200	8"	210129	1 U
TCXBPE 60X300	300	12"	210130	1 U
TCXBPE 100X200	200	8"	210131	1 U
TCXBPE 100X300	300	12"	210132	1 U
TCXBPE 100X400	400	16"	210133	1 U
TCXBPE 100X600	600	24"	210134	1 U

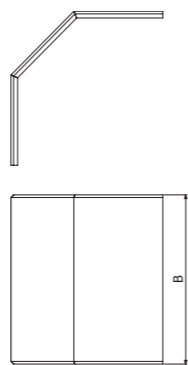

TCXBPE B100-400 TCXBPE 600W

**PDBPE**

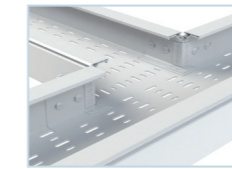

PDBPE 60  
PDBPE 100

1 x PDBPE 60 + 2/100 CTPB (210017)  
 1 x PDBPE 100 + 4/100 CTPB (210017)

UVM1 7035	
REF	MOQ
223021	10 U
223022	10 U

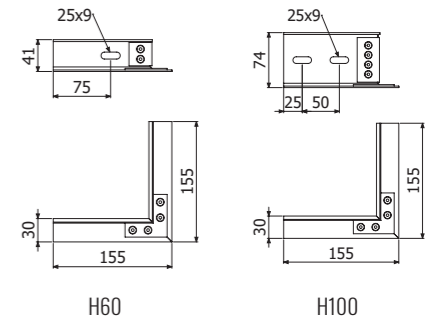

H60

H100

**TFBPE**



	H		B		UVM1 7035	
	mm	inch	mm	inch	REF	MOQ
TFBPE 60X100	60	2 3/8"	100	4"	223023	2 U
TFBPE 60X150	60	2 3/8"	150	6"	223024	2 U
TFBPE 60X200	60	2 3/8"	200	8"	223025	1 U
TFBPE 60X300	60	2 3/8"	300	12"	223026	2 U
TFBPE 100X200	100	4"	200	8"	223027	2 U
TFBPE 100X300	100	4"	300	12"	223028	2 U
TFBPE 100X400	100	4"	400	16"	223029	2 U
TFBPE 100X600	100	4"	600	24"	223030	2 U

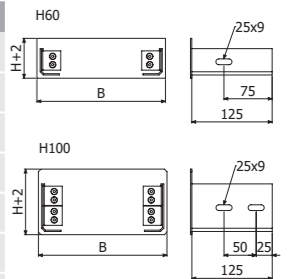

1 x TFBPE H60 + 2/100 CTPB (210017)  
 1 x TFBPE H100 + 4/100 CTPB (210017)

**PSBPE**

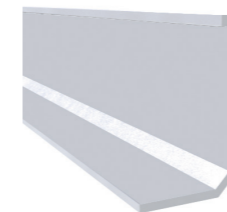

L = 3 m (10 ft)



	H		UVM1 7035	
	mm	inch	REF	MOQ
PSBPE 60	60	2 3/8"	210144	30 M
PSBPE 100	100	4"	210145	30 M

4/100 CTPB (210017)

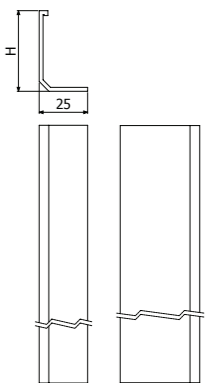

**JUBPE**



	H		UVM1 7035	
	mm	inch	REF	MOQ
JUBPE 60	60	2 3/8"	210084	10 U
JUBPE 100	100	4"	210085	10 U

2 x JUBPE 60 → 4/100 CTPB (210017)  
 2 x JUBPE 100 → 8/100 CTPB (210017)

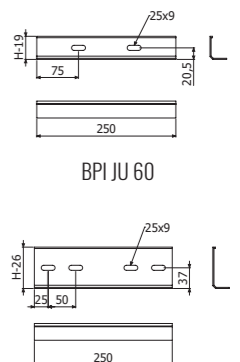

BPI JU 60

BPI JU 100

**JUBPE-C**



JUBPE-C 400-600

4/100 x CTBP (210017)

UVM1 7035	
REF	MOQ
218797	7 U

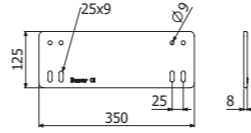

**JUBPE-AB**

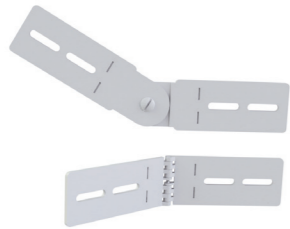

Kit JUBPE-AB 60

Kit JUBPE-AB 100

2 x JUBPE-A → 8/100 CTBP (210017)

	H		A	UVM1 7035	
	mm	inch		REF	MOQ
Kit JUBPE-AB 60	32	2 3/8"	+/- 90	223613	10 U
Kit JUBPE-AB 100	63	1 1/4"	+/- 90	223614	10 U

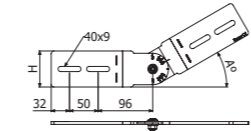

JUBPE-A

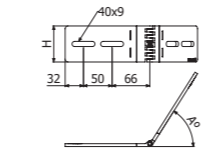

JUBPE-B

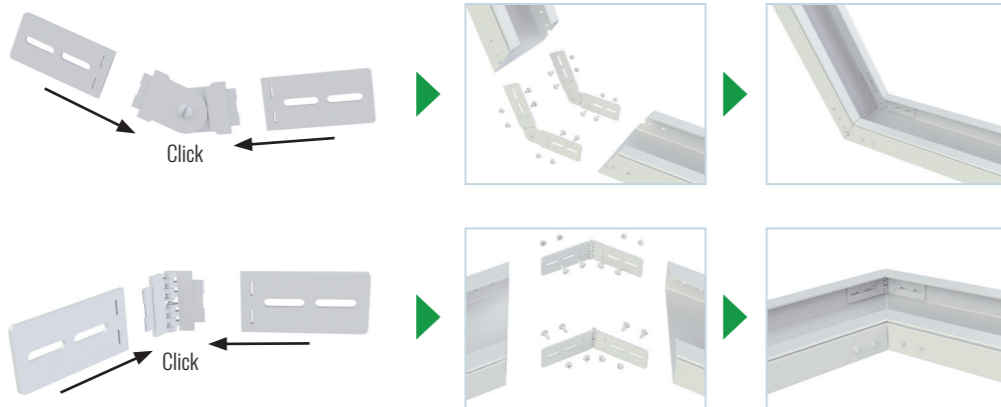
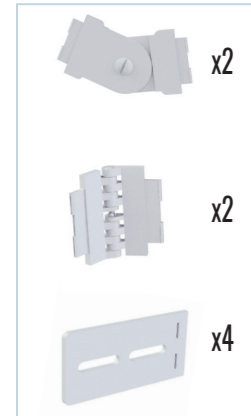

**BIK10-BPE**



	e	Mod.	i304	
			REF	MOQ
BIK10-BPE 60X100	1,5	60x100	217340	10 U
BIK10-BPE 60X150	1,5	60x150	217341	10 U
BIK10-BPE 60/100x200	1,5	60X200 & 100X200	217342	10 U
BIK10-BPE 60/100X300	1,5	60X300 & 100X300	217343	10 U
BIK10-BPE 100X400	2	100X400	217345	10 U
BIK10-BPE 100X600	2	100X600	217346	10 U

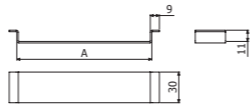

3 x BIK10-BPE => 1 x TBPE



**CTBP**



	Pap	UVM1 7035	
		REF	MOQ
CTBP-100	2,5	210017	1 U

13

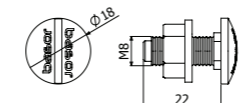

**CTA kg (lb)**

SHG



T°	B mm (inch)					
	100 (4")	150 (6")	200 (8")	300 (12")	400 (16")	600 (24")
40°C	166 (366)	105 (231)	125 (276)	291 (642)	207 (456)	148 (326)
60°C	113 (249)	95 (209)	120 (264)	178 (392)	160 (353)	113 (249)

RoHS OK

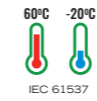

**CTA kg (lb)**

PSHG



T°	B mm (inch)					
	100 (4")	150 (6")	200 (8")	300 (12")	400 (16")	600 (24")
40°C	166 (366)	105 (231)	125 (276)	291 (642)	207 (456)	148 (326)
60°C	113 (249)	95 (209)	120 (264)	178 (392)	160 (353)	113 (249)

RoHS OK

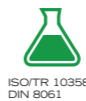
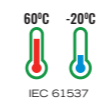

**CTA kg (lb)**

SVG



T°	B mm (inch)					
	100 (4")	150 (6")	200 (8")	300 (12")	400 (16")	600 (24")
40°C	312 (687)	262 (577)	213 (469)	171 (379)	162 (358)	77 (170)

RoHS OK

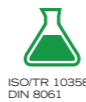
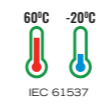

**SHG**



	B		40°		60°		UVM1 7035	
	mm	inch	CTA (kg)	CTA (lb)	CTA (kg)	CTA (lb)	REF	MOQ
SHG 100	100	4"	166	366	113	249	210011	8 U
SHG 150	150	6"	105	231	95	209	210012	8 U
SHG 200	200	8"	125	276	120	120	210013	4 U
SHG 300	300	12"	291	642	178	392	210014	4 U
SHG 400	400	16"	207	456	160	353	210015	2 U
SHG 600	600	24"	148	326	113	249	210016	2 U

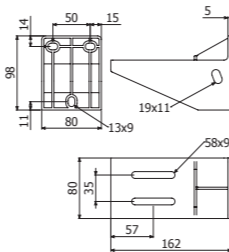

SHG100

BPE ----> SHG: 2/100 x CTBP (210017)

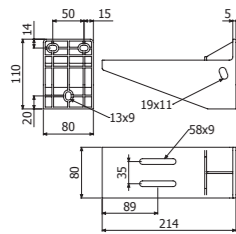

SHG150

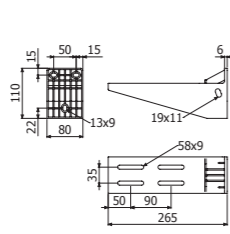

SHG200

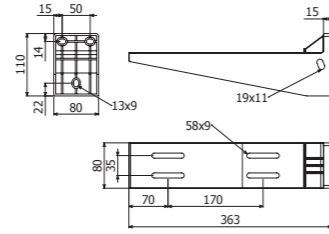

SHG300

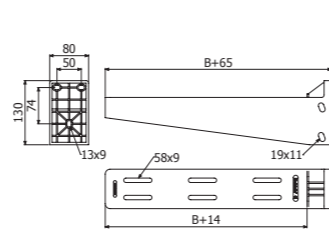

SHG 400/600

**SVG**

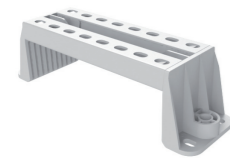

	B		CTA 40°		UVM1 7035	
	mm	inch	kg	lb	REF	MOQ
SVG 100	100	4"	312	687	210050	1 U
SVG 150	150	6"	262	577	210051	1 U
SVG 200	200	8"	213	469	210052	1 U
SVG 300	300	12"	171	379	210053	1 U
SVG 400	400	16"	162	358	210054	1 U
SVG 600	600	24"	77	170	210055	1 U

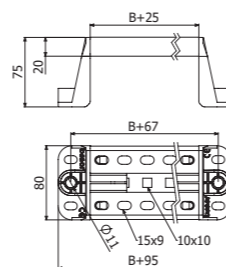

BPE ----> SVG: 2/100 x CTBP (210017)



**KSHGR**



KSHGR	GSP 7035	
	REF	MOQ
KSHGR	217282	1 U

PSHGR ----> KSHGR 4/100 x B2 (205392-i304)  
 SHG 100~300 ----> KSHGR 1 x CT2 M10x100 (207228-i304)  
 SHG 400~600 ----> KSHGR 2 x CT2 M10x100 (207228-i304)

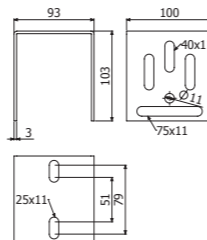

**PSHG**



**PSHG 2M**

SHG 100~300 ----> PSHG 1 x CT2 M10x100 (207228-i304)  
 SHG 400~600 ----> PSHG 2 x CT2 M10x100 (207228-i304)

GSP 7035	
REF	MOQ
217281	12 M

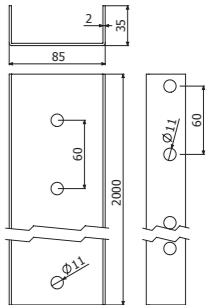

**PSHGR**



**PSHGR 600**

TFSHGR PVC (212112)

PSHGR ----> KSHGR 4/100 x B2 (205392-i304)  
 SHG 100~300 ----> PSHGR 1 x CT2 M10x100 (207228-i304)  
 SHG 400~600 ----> PSHGR 2 x CT2 M10x100 (207228-i304)

GSP 7035	
REF	MOQ
217283	2 U

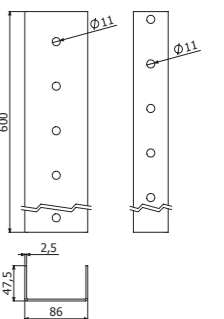

PSHGR

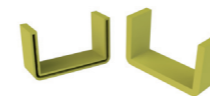

TFSHGR

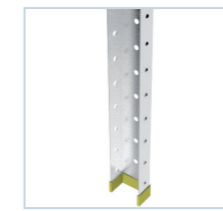

SHGR+TFSHGR

**CT2**



**CT2 M10X100**

17

Pap	i304	
	REF	MOQ
Nm	207228	50 U

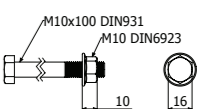

**B2**



**B2-100**

13

Pap	i304	
	REF	MOQ
Nm	205392	1 U

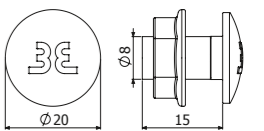

# BasorCANAL

## BasorCANAL WT

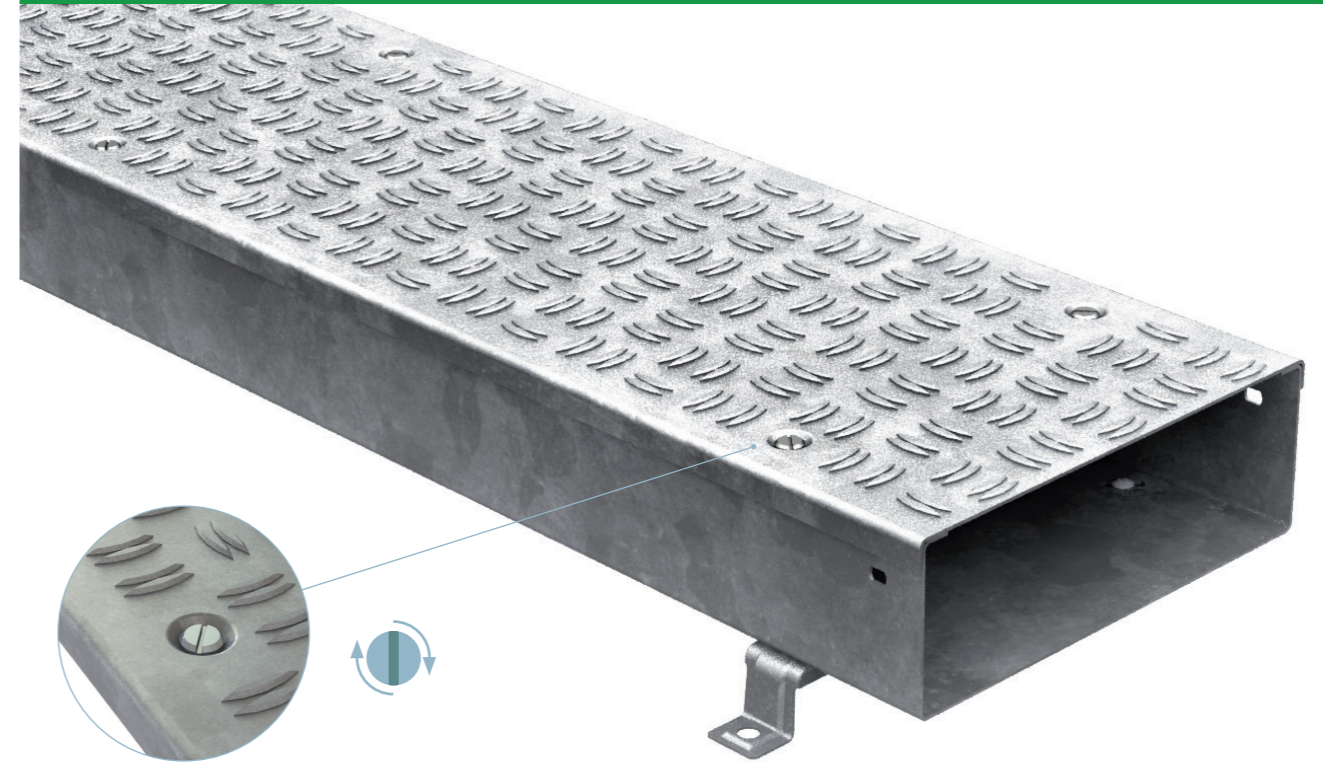

L > 100m  
UNE-EN 50085

NO + MO  
UNE-EN 50085  
UNE 23727

120°C -25°C  
UNE-EN 50085

3  
UNE-EN 61537

20J  
UNE-EN 50085

OK

IP20  
IEC 60529

IK10  
IEC 50102

CPWT

TCPWT

TSCPWT

CPWT45

TCPWT45

TSCPWT45

TEWT

TTEWT

TSTEWT

CRWT

TCRWT

CCWT

PSWT

REWT

TFWT

JUWT

SV

B1

DIN 7991

TMK

Filling Area			
B		H100 (4")	
mm	inch	cm <sup>2</sup>	in <sup>2</sup>
100	4	85,56	13,26
200	8	181,56	28,14
300	12	277,56	43,02
400	16	371,32	57,55
500	20	467,32	72,43
600	24	563,32	87,31

BasorCANAL

BasorCANAL



WT PG



L = 2 m (6,6 ft)

	Kg	B		H		PG	
		mm	inch	mm	inch	REF	MOQ
WT 100X100	150	100	4	100	4	210146	4 M
WT 200X100	150	200	8	100	4	210147	4 M
WT 300X100	150	300	12	100	4	210148	4 M
WT 400X100	150	400	16	100	4	210149	4 M
WT 500X100	150	500	20	100	4	210150	4 M
WT 600X100	150	600	24	100	4	210151	4 M

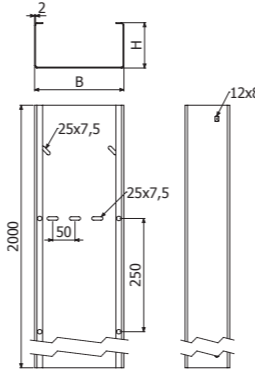

- 2 x JUWT (210177) + 4/100 x B1 (204356)
- 2m x WT --> 3 x SV (B) + 2/100 x B1 (204356)
- B ≥ 400 --> 1 x PSWT

TWT PG

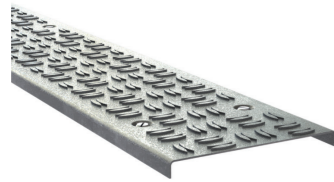

L = 2 m (6,6 ft)

	B		PG	
	mm	inch	REF	MOQ
TWT 100	100	4"	224245	2 M
TWT 200	200	8"	224246	2 M
TWT 300	300	12"	224247	2 M
TWT 400	400	16"	224248	2 M
TWT 500	500	20"	224249	2 M
TWT 600	600	24"	224250	2 M

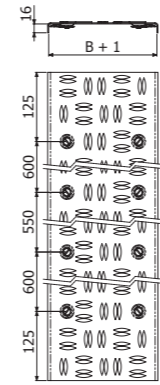

- 1 x PSWT (210180) --> TWT (400 - 600)

TWT AL



L = 2 m (6,6 ft)

	Kg	B		AL	
		mm	inch	REF	MOQ
TWT 100	150	100	4	210191	2 M
TWT 200	150	200	8	210192	2 M
TWT 300	150	300	12	210193	2 M
TWT 400	150	400	16	210194	2 M
TWT 500	150	500	20	210195	2 M
TWT 600	150	600	24	210196	2 M

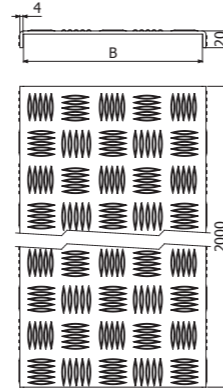

- 6/100 x DIN 7991 M6x16 (210265 - EZ)
- 1 x PSWT (210180) --> TWT (400 - 600)

TSWT PG



L = 2 m (6,6 ft)

	B		PG	
	mm	inch	REF	MOQ
TSWT 100	100	4	210185	2 M
TSWT 200	200	8	210186	2 M
TSWT 300	300	12	210187	2 M
TSWT 400	400	16	210188	2 M
TSWT 500	500	20	210189	2 M
TSWT 600	600	24	210190	2 M

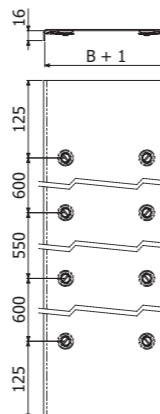

- 6/100 x DIN 7991 M6x16 (210265 - EZ)
- 1 x PSWT (210180) --> TWT (400 - 600)

CPWT PG



	Kg	B		H		PG	
		mm	inch	mm	inch	REF	MOQ
CPWT 100X100	150	100	4	100	4	210152	1 U
CPWT 200X100	150	200	8	100	4	210153	1 U
CPWT 300X100	150	300	12	100	4	210154	1 U
CPWT 400X100	150	400	16	100	4	210155	1 U
CPWT 500X100	150	500	20	100	4	210156	1 U
CPWT 600X100	150	600	24	100	4	210157	1 U

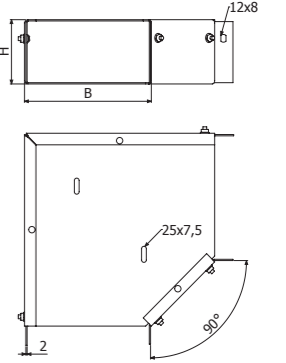

- 4/100 x B1 (204356 - EZ)
- 1 x CPWT --> 1 x SV (B)
- JUWT

TCPWT PG

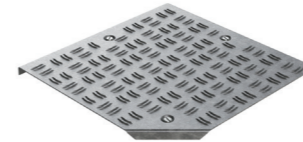

	B		PG	
	mm	inch	REF	MOQ
TCPWT 100	100	4"	224251	1 U
TCPWT 200	200	8"	224252	1 U
TCPWT 300	300	12"	224253	1 U
TCPWT 400	400	16"	224254	1 U
TCPWT 500	500	20"	224255	1 U
TCPWT 600	600	24"	224256	1 U

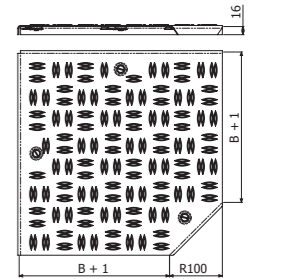

TCPWT AL



	Kg	B		AL	
		mm	inch	REF	MOQ
TCPWT 100	150	100	4	210197	1 U
TCPWT 200	150	200	8	210198	1 U
TCPWT 300	150	300	12	210199	1 U
TCPWT 400	150	400	16	210200	1 U
TCPWT 500	150	500	20	210201	1 U
TCPWT 600	150	600	24	210202	1 U

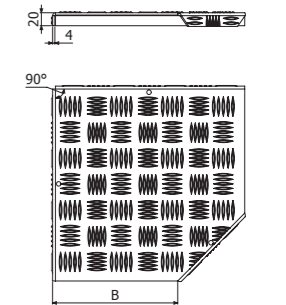

- B=100,200,300 3/100 x DIN 7991 M6x16 (210265 - EZ)
- B=400,500,600 5/100 x DIN 7991 M6x16 (210265 - EZ)

TSCPWT PG

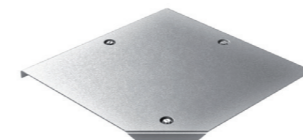

	B		PG	
	mm	inch	REF	MOQ
TSCPWT 100	100	4	210203	1 U
TSCPWT 200	200	8	210204	1 U
TSCPWT 300	300	12	210205	1 U
TSCPWT 400	400	16	210206	1 U
TSCPWT 500	500	20	210207	1 U
TSCPWT 600	600	24	210208	1 U

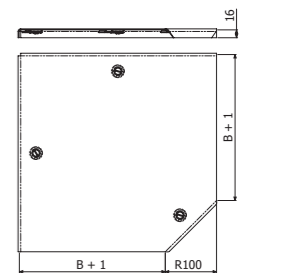

- B=100,200,300 3/100 x DIN 7991 M6x16 (210265 - EZ)
- B=400,500,600 5/100 x DIN 7991 M6x16 (210265 - EZ)



**CRWT PG**

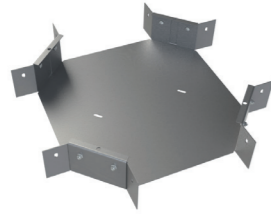

	H		B		PG	
	mm	inch	mm	inch	REF	MOQ
CRWT 100X100	100	4	100	4	210292	1 U
CRWT 200X100	100	4	200	8	210293	1 U
CRWT 300X100	100	4	300	12	210294	1 U
CRWT 400X100	100	4	400	16	210295	1 U
CRWT 500X100	100	4	500	20	210296	1 U
CRWT 600X100	100	4	600	24	210297	1 U

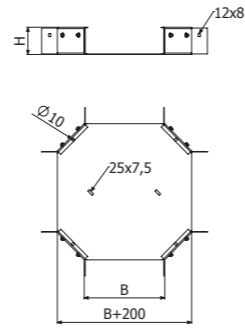

8/100 x B1 (204356 - EZ)

1 x CRWT --> 1 x SV (B)



**TCRWT PG**

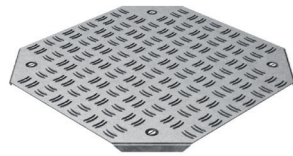

	B		PG	
	mm	inch	REF	MOQ
TCRWT 100	100	4"	224269	1 U
TCRWT 200	200	8"	224270	1 U
TCRWT 300	300	12"	224271	1 U
TCRWT 400	400	16"	224272	1 U
TCRWT 500	500	20"	224273	1 U
TCRWT 600	600	24"	224274	1 U

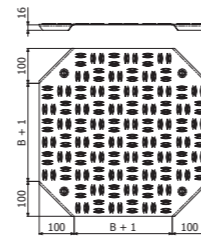

**TCRWT AL**

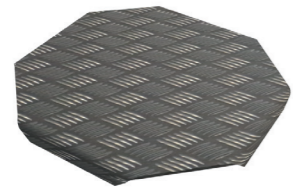

	B		AL	
	mm	inch	REF	MOQ
TCRWT 100	100	4	210298	1 U
TCRWT 200	200	8	210299	1 U
TCRWT 300	300	12	210300	1 U
TCRWT 400	400	16	210301	1 U
TCRWT 500	500	20	210302	1 U
TCRWT 600	600	24	210303	1 U

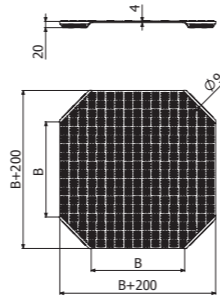

4/100 x DIN 7991 M6x16 (210265 - EZ)

**TSCRWT PG**



	B		PG	
	mm	inch	REF	MOQ
TSCRWT 100	100	4"	224986	1 U
TSCRWT 200	200	8"	224987	1 U
TSCRWT 300	300	12"	224988	1 U
TSCRWT 400	400	16"	224989	1 U
TSCRWT 500	500	20"	224990	1 U
TSCRWT 600	600	24"	224991	1 U

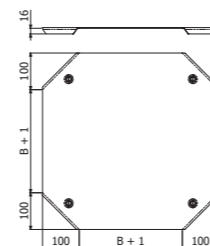

**CCWT GS**



	B		H		PG	
	mm	inch	mm	inch	REF	MOQ
CCWT 100X100	100	4	100	4	210171	1 U
CCWT 200X100	200	8	100	4	210172	1 U
CCWT 300X100	300	12	100	4	210173	1 U
CCWT 400X100	400	16	100	4	210174	1 U
CCWT 500X100	500	20	100	4	210175	1 U
CCWT 600X100	600	24	100	4	210176	1 U

4/100 x B1 (204356 - EZ)



JUWT

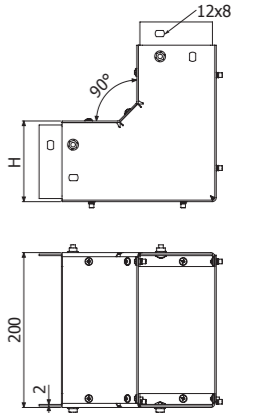

CCCX WT

**PSWT GS**



	PG	
	REF	MOQ
PSWT 100	210180	2 M

4/100 x B1 (204356 - EZ)

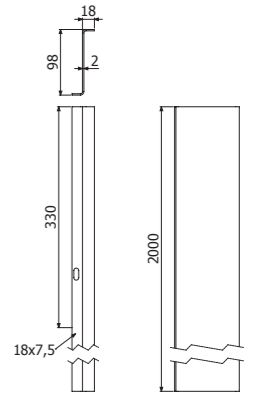

**REWT GS**



	H		PG	
	mm	inch	REF	MOQ
REWT 100X100	107	4	210087	1 U

2/100 x B1 (204356 - EZ)

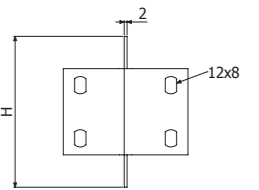

**TFWT GS**

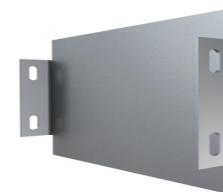

	B		H		PG	
	mm	inch	mm	inch	REF	MOQ
TFWT 100X100	100	4	100	4	210240	1 U
TFWT 200X100	200	8	100	4	210241	1 U
TFWT 300X100	300	12	100	4	210242	1 U
TFWT 400X100	400	16	100	4	210243	1 U
TFWT 500X100	500	20	100	4	210244	1 U
TFWT 600X100	600	24	100	4	210245	1 U

2/100 x B1 (204356 - EZ)

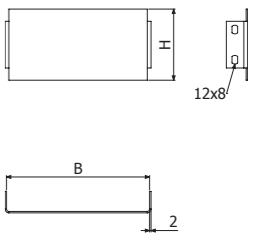

### JUWT PG



JUWT 100

2/100 x B1 (204356 - EZ)

PG	
REF	MOQ
210177	5 U

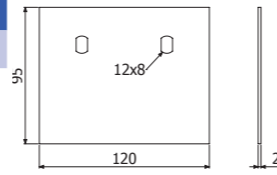

### SV GS



SV 100/150/200/300



SV 400/500/600

	B		e	CTA		PG	
	mm	inch		kg	lb	REF	MOQ
SV100	100	4"	1,5	276	609	201046	10 U
SV150	150	6"	1,5	253	558	201047	6 U
SV200	200	8"	1,5	253	558	201048	6 U
SV300	300	12"	1,5	207	456	201049	6 U
SV400	400	16"	1,5	506	1116	203413	5 U
SV500	500	20"	1,5	460	1014	203414	5 U
SV600	600	24"	1,5	414	912	203415	5 U

2/100 x B1 (204356 - EZ)

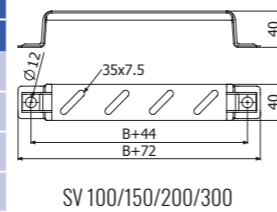

SV 100/150/200/300

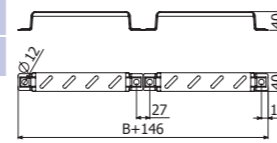

SV 400/500/600

### B1



B1-100

10

Pap N·m	L mm	EZ	
		REF	MOQ
6	14	204356	1 U

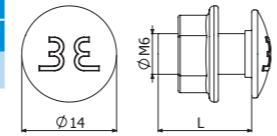

### DIN 7991



DIN7991-100 M6X16

4

Pap N·m	L mm	EZ	
		REF	MOQ
8		210265	1 U

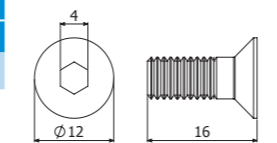

### TMK

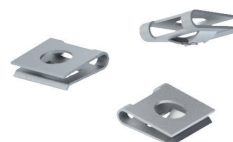

TMK-100 M6

1

HDG	
REF	MOQ
210266	1 U

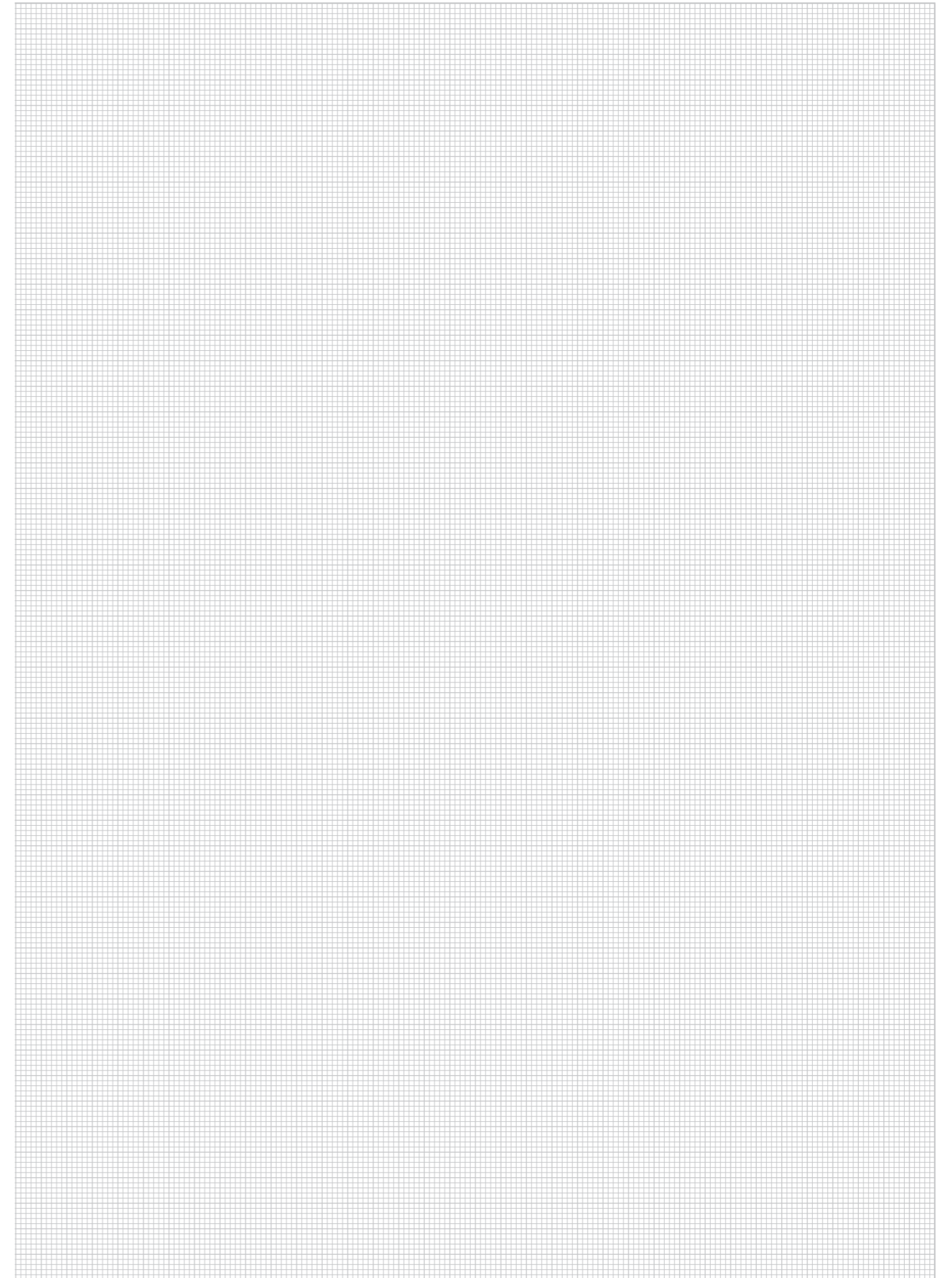
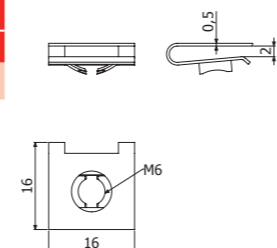



# BasorTUB

## BasorTUB RLH-CLH-PVC



### RE1250 RLH



	DN		h		EN IEC 61386	IP	IK	RLH 7035	
	mm	inch	mm	inch				REF	MOQ
RE1250 16	16	5/8"	14	1/2"	4322	54	7	206453	114 M
RE1250 20	20	3/4"	16	5/8"	4322	54	7	206454	57 M
RE1250 25	25	1"	20	3/4"	4322	54	7	206455	57 M
RE1250 32	32	1 1/4"	22	7/8"	4322	54	7	206456	30 M
RE1250 40	40	1 5/8"	26	1"	4322	54	7	206457	30 M
RE1250 50	50	2"	31	1 1/4"	4322	54	7	206458	15 M
RE1250 63	63	2 1/2"	60	2 3/8"	4322	54	7	206459	15 M

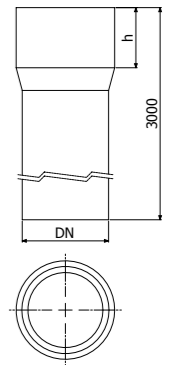

### R1250 CLH



	DN		EN IEC 61386	IK	CLH 7035	
	mm	inch			REF	MOQ
R1250 16	16	5/8"	4422	8	207217	114 M
R1250 20	20	3/4"	4422	8	207218	57 M
R1250 25	25	1"	4422	8	207219	57 M
R1250 32	32	1 1/4"	4422	8	207220	30 M
R1250 40	40	1 5/8"	4422	8	207221	30 M
R1250 50	50	2"	4422	8	207222	15 M

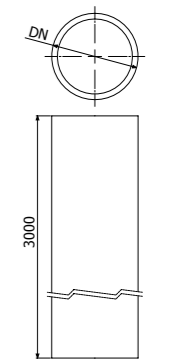



**BasorFIX**

**BCA**



	E <sub>max</sub> mm	H kg	Pap N-m	e mm	HDG	
					REF	MOQ
BCA 41X41	20	90	26	6	208809	25 U
BCA 41X82	20	130	26	6	208810	25 U

P41 41X41, P41 41X82 (HDG)

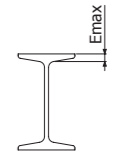
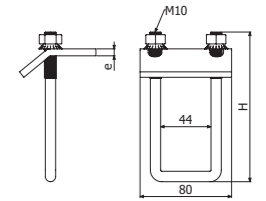
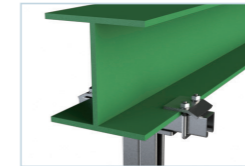

**BCAL**



	e mm	PG	
		REF	MOQ
BCAL	4	224936	4 U

CT40 - P41 41X21 - P41 41X41 (PG)

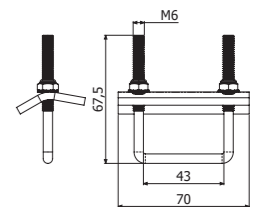

**GV2**



	e mm	PG		i304	
		REF	MOQ	REF	MOQ
GV2	3	215501	26 U	218642	10 U

M8 & M10

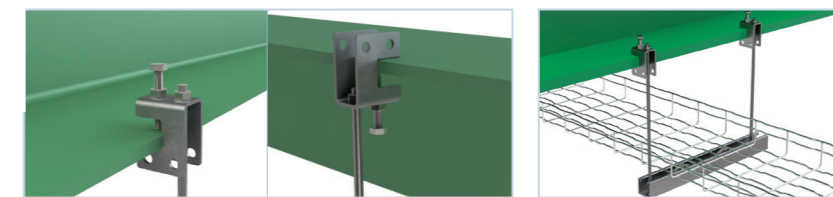

200 Kg

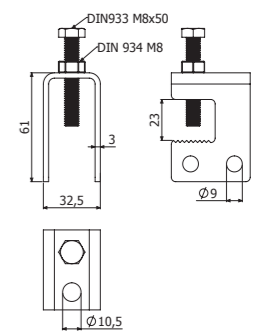

**BVL**



BVL41



BVL82

	e mm	HDG	
		REF	MOQ
BVL41	60	211230	14 U
BVL82	100	211231	1 U

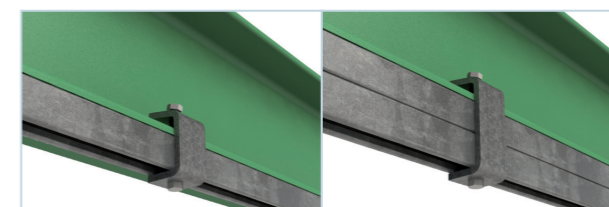

BVL41 + 41X41

BVL82 + 41X82

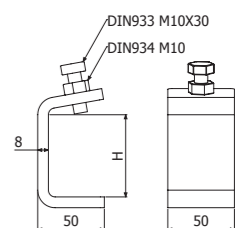

# BasorFIX

GVV2 GS



GVV2

M8 & M10

PG	
REF	MOQ
207073	42 U

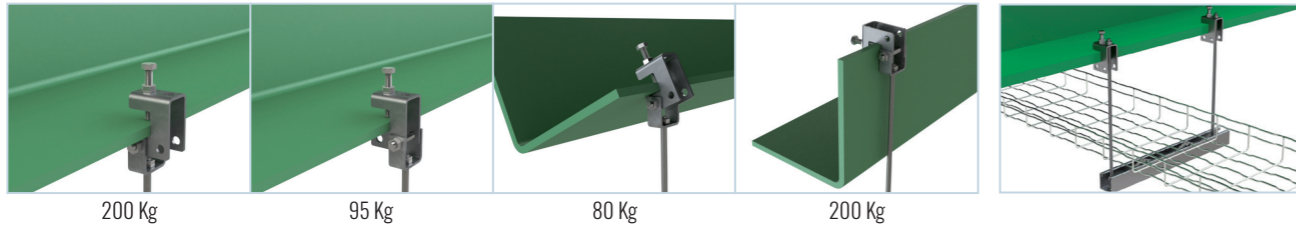
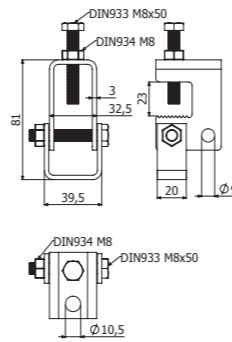

BRP

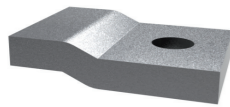

BRP

M10

E <sub>max</sub>	Q <sub>reac</sub>	HDG85	
		REF	MOQ
5	1000	205624	1 U

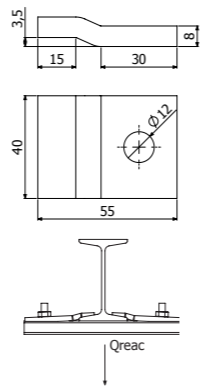

DIN976 & MVR



DIN976



MVR

	L	Q <sub>trac</sub>	EZ		i304	
			REF	MOQ	REF	MOQ
DIN976 M6X1000	1000	400	217562	100 U	Ⓢ	50 U
DIN976 M8X1000	1000	800	203397	50 U		
DIN976 M10X1000	1000	1400	205535	25 U	Ⓢ	100 U
DIN976 M12X1000	1000	2500	206502	10 U		
MVR M6	-	-	206323	100 U		
MVR M8	-	-	204462	200 U	207402	100 U

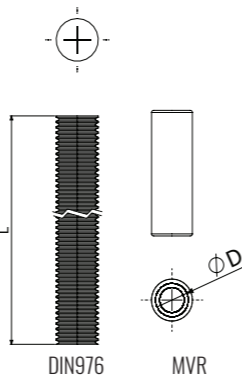

CSJ



CSJ

M6

	AL		i430	
	REF	MOQ	REF	MOQ
CSJ	203461	10 M	203462	10 M

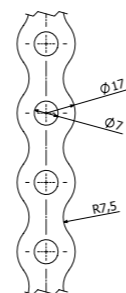

RA / CT



L = 2 - 3 m (6,56 - 10 ft)



	B	H	C	e	A	W <sub>x</sub>	W <sub>y</sub>	PG		HDG	
								REF	MOQ	REF	MOQ
RA35 3M	35	14	15	1,5	0,9	0,37	1,04	200237	30 M	200238	3 M
RA35 2M	35	14	15	1,5	0,9	0,37	1,04	203484	32 M	-	-
RA50 3M	50	14	30	1,5	1,1	0,37	1,78	200239	30 M	200240	3 M
CT40 3M	40	20	20	1,5	1,25	0,64	1,6	204471	24 M	200246	2 M
CT40 2M	40	20	20	1,5	1,25	0,64	1,6	205656	24 M	Ⓢ	
CT20 2M	20	10	10	1	0,38	0,09	0,25	200242	40 M		
CT20-C 2M	20	10	10	1	0,44	0,1	0,25	200241	40 M		

M6, M8

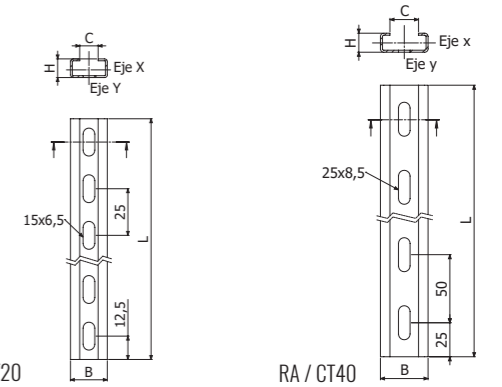

JURA

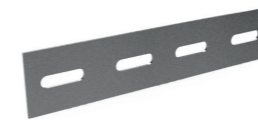

	B	PG		HDG	
		REF	MOQ	REF	MOQ
JURA 35	28	201122	60 U	201123	60 U
JURA 50	40	201124	40 U	203473	40 U

M6

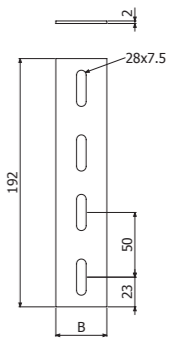

C-SVO\*

\*SCM

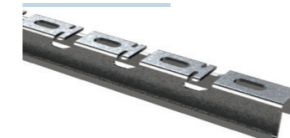

L = 3 m (10 ft)



	B	H	e	PG		HDG		e	i304	
				REF	MOQ	REF	MOQ		mm	
C-SVO 3M	52	20	2	201101	24 M	207436	3 M	1,5	206415	3 M



M6, M8

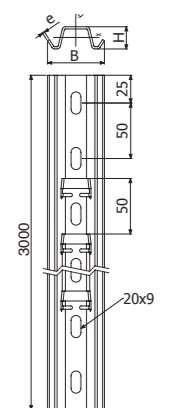



**OBP / OBC / OAP / OAC**



OBP

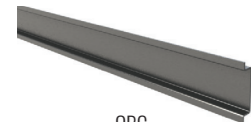

OBC



OAP

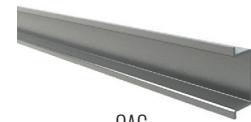

OAC

**OR**

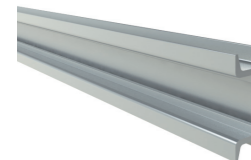

	e	B	H	GS	
				REF	MOQ
OBP	1	35	7	200248	40 M
OBC	1	35	7	207214	40 M
OAP	1,5	35	15	200250	40 M
OAC	1,5	35	15	207227	40 M

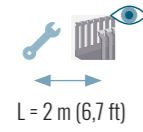

L = 2 m (6,7 ft)

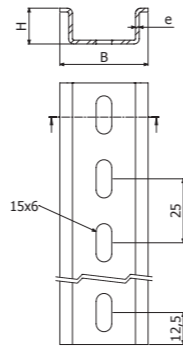

	B		H		L		AL	
	mm	inch	mm	inch	mm	inch	REF	MOQ
OR 3M	35	1 3/8	15	3/5	3	10	209806	3 M

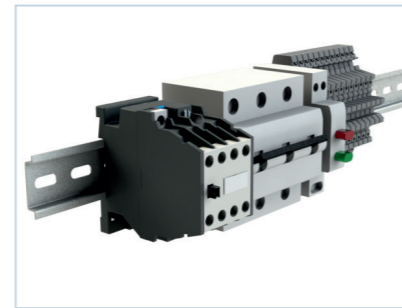
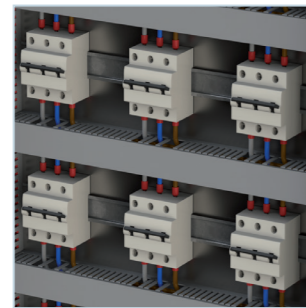
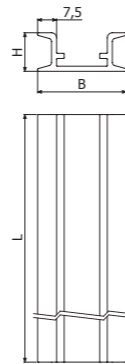

**P41 41X21**

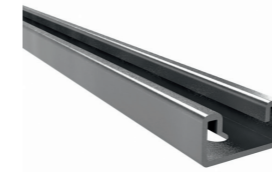

L = 3 m (10 ft)

	e	A		Wx		Wy		PG		HDG	
		mm	cm <sup>2</sup>	in <sup>2</sup>	cm <sup>3</sup>	in <sup>3</sup>	cm <sup>3</sup>	in <sup>3</sup>	REF	MOQ	REF
41X21X1,5 D11X25	1,5	1,44	0,22	0,79	0,05	1,86	0,11	206366	3 M		
41x21x2 D13x28	2	1,84	0,28	0,94	0,06	2,34	0,14	218677	3 M		
41X21X2,5 D11X25	2,5	2,14	0,33	1,08	0,07	2,73	0,16	200235	3 M	2/0236	3 M

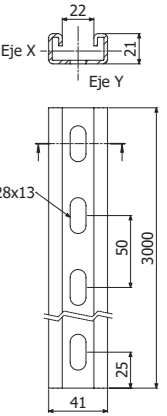

**P41 41X41**

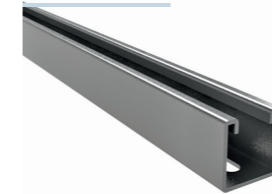

L = 3 m (10 ft)

	e	A		Wx		Wy		PG		HDG	
		mm	cm <sup>2</sup>	in <sup>2</sup>	cm <sup>3</sup>	in <sup>3</sup>	cm <sup>3</sup>	in <sup>3</sup>	REF	MOQ	REF
41X41X1,5 D11X25	1,5	1,95	0,3	2,09	0,12	2,92	0,17	206365	3 M		
41X41X2,5 D11X25	2,5	3,21	0,5	3,2	0,19	4,59	0,28	200233	3 M	2/0234	3 M
41x41x2 D13x28	2	2,60	0,40	2,71	0,16	3,83	0,23	208673	3 M	-	-

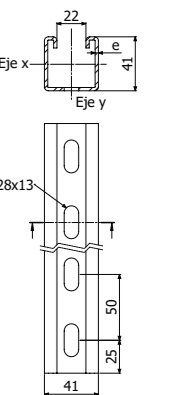

**P41-3S 41X41X2**



L = 3 m (10 ft)

	e	A		Wx		Wy		PG	
		mm	cm <sup>2</sup>	in <sup>2</sup>	cm <sup>3</sup>	in <sup>3</sup>	cm <sup>3</sup>	in <sup>3</sup>	REF
41X41X2-3S D13X28	2	2,08	0,32	2,68	0,16	2,86	0,19	217313	3 M

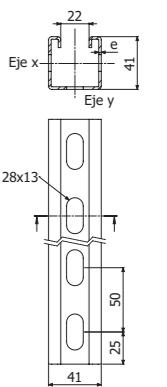

**P41-D 41X82**

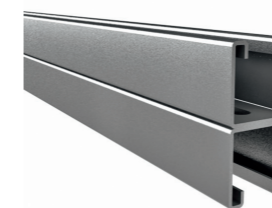

L = 3 m (10 ft)

	e	A		Wx		Wy		HDG	
		mm	cm <sup>2</sup>	in <sup>2</sup>	cm <sup>3</sup>	in <sup>3</sup>	cm <sup>3</sup>	in <sup>3</sup>	REF
P41-D 41X82X2 D11X25	2	5,25	0,81	7,96	0,48	7,63	0,46		
P41-D 41X82X2,5 D11X25	2,5	6,37	0,98	9,49	0,57	9,11	0,55	205573	3M

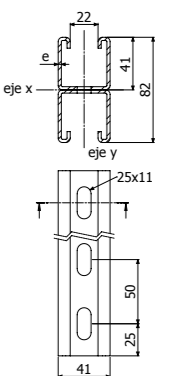

# ACC 41/82



## K41



Qreac	HDG70	
	REF	MOQ
700	205622	10 U

2 x T M10X30 (217547 - i304) + 2 x TM M10 (217584 HDG)

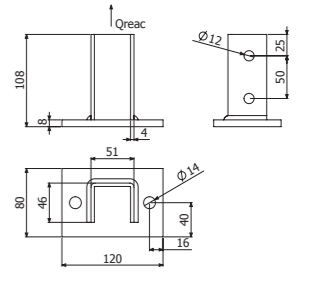

## K41-3S



EZ	HDG70	
	REF	MOQ
218656		10 U

2 x CT2 M10X65 (218704-EZ)

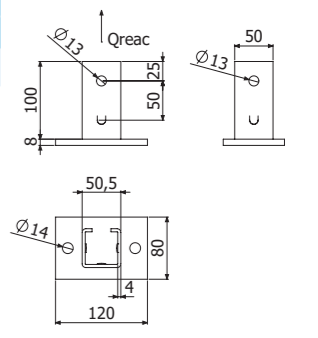

## K82

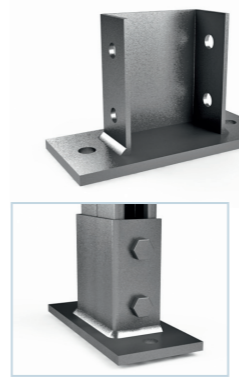

Qreac	HDG70	
	REF	MOQ
1100	205574	1 U

4 x T M10X30 (217547-i304) + 4 x TM M10 (217584-HDG)

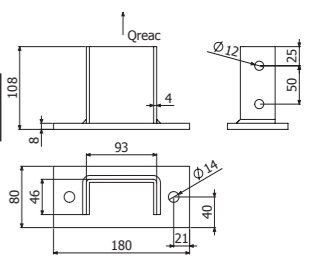

## K82ME

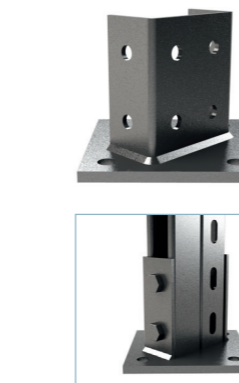

Qreac	HDG70	
	REF	MOQ
1100	207020	1 U

1x [U-profile] + [Bracket] + 2 x T M10X30 (217547-i304) + 2 TM M10 (217584-HDG) + 2/50 x B3 (208827-HDG)

2x [Bracket] + 4 x T M10X30 (217547 - i304) + 4 x TM M10 (217584-HDG)

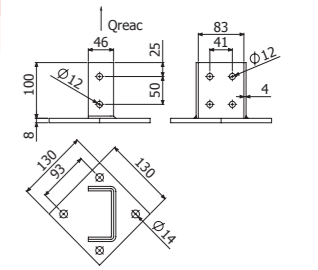

### SBL41



	Qreac	e	PG		HDG70	
	Kg	mm	REF	MOQ	REF	MOQ
SBL41	600	4	207058	1 U	206472	1 U

2 X T M10X30 (217547-i304) + 2 TM M10 (217584-HDG)

2/50 x B3 (208827 - HDG)

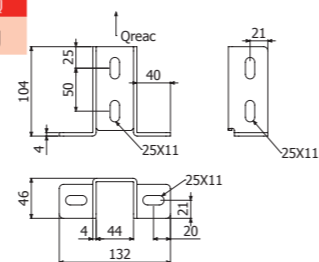

### KA41

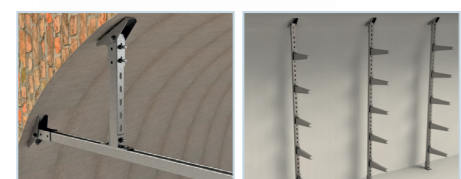

	Qreac	HDG	
	Kg	REF	MOQ
KA41	1000	206475	1 U

2 X T M10X30 (217547-i304) + 2 TM M10 (217584-HDG)

2/50 x B3 (208827 - HDG)

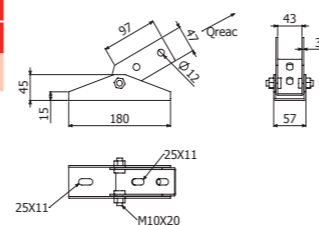

### SB41



	Qreac	HDG70	
	Kg	REF	MOQ
SB41	700	206471	1 U

2 X T M10X30 (217547-i304) + 2 TM M10 (217584-HDG)

2/50 x B3 (208827 - HDG)

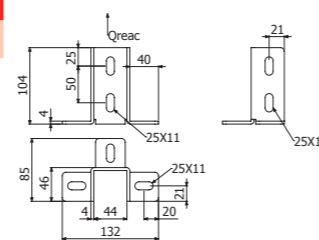

### SBL41-3S



	e	PG	
	mm	REF	MOQ
SBL41	4	218657	1 U

2 x CT2 M10X65 ( 218704)

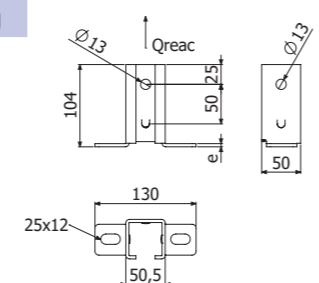

### 4182CR

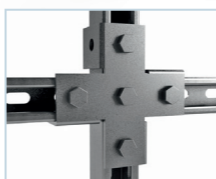

	HDG70	
	REF	MOQ
4182CR	206473	1 U

5 X T M10X30 (217547-i304) + 5 TM M10 (217584-HDG)

5/50 x B3 (208827 - HDG)

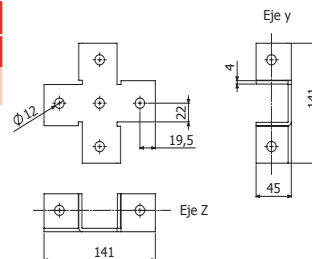

### 4182TE



	HDG70	
	REF	MOQ
4182TE	206474	1 U

4 X T M10X30 (217547-i304) + 4 X TM M10 (217584-HDG)

4/50 x B3 (208827 - HDG)

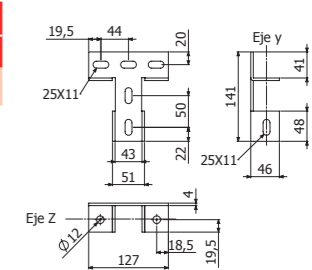

### 4182CV

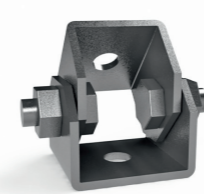

	Qreac	HDG	
	Kg	REF	MOQ
4182CV	500	206477	20 U

M8 & M10

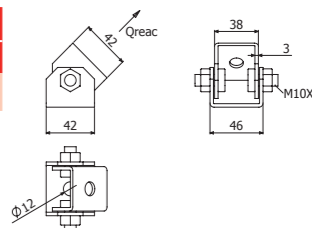

### 4182A

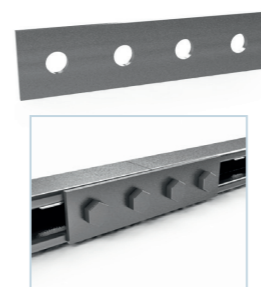

	HDG70	
	REF	MOQ
4182A	206311	12 U

4 X T M10X30 (217547-i304) + 4 X TM M10 (217584-HDG)

4/50 x B3 (208827 - HDG)

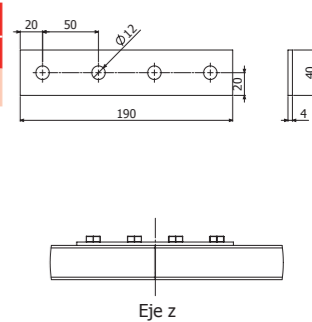

**4182B**

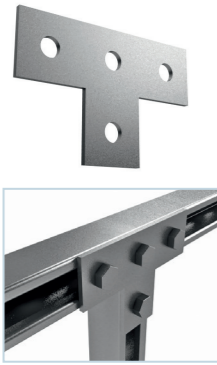

4182B

- 4 X T M10X30 (217547-i304) + 4 X TM M10 (217584-HDG)
- 4/50 x B3 (208827 - HDG)

HDG70	
REF	MOQ
206312	12 U

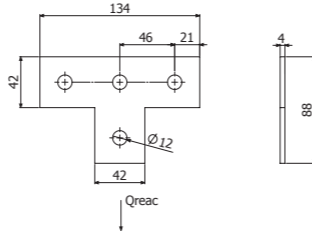

**4182C**



4182C

- 2 X T M10X30 (217547-i304) + 2 X TM M10 (217584-HDG)
- 2/50 x B3 (208827 - HDG)

HDG70	
REF	MOQ
206313	50 U

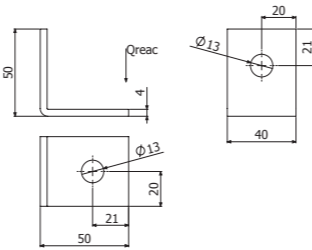

**4182CD**



4182CD

- 3 X T M10X30 (217547-i304) + 3 X TM M10 (217584-HDG)
- 3/50 x B3 (208827 - HDG)

HDG70	
REF	MOQ
207127	1 U

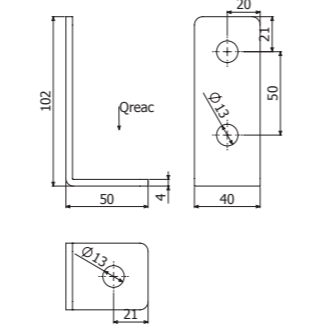

**4182D**

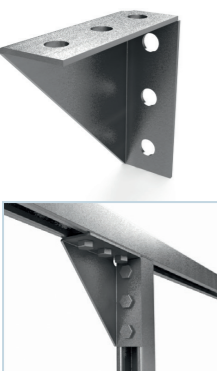

4182D

- 4 X T M10X30 (217547-i304) + 4 X TM M10 (217584-HDG)
- 4/50 x B3 (208827 - HDG)

HDG	
REF	MOQ
206314	1 U

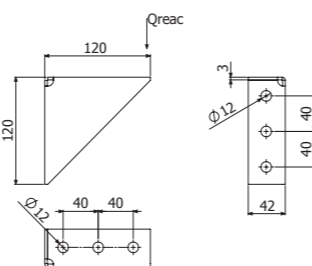

**4182E**

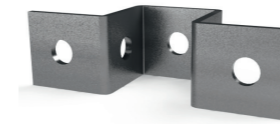

4182E

- 3 X T M10X30 (217547-i304) + 3 X TM M10 (217584-HDG)

HDG70	
REF	MOQ
206315	16 U

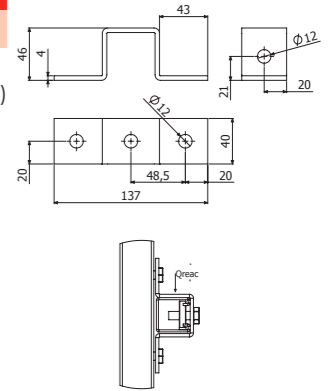

**4182F**

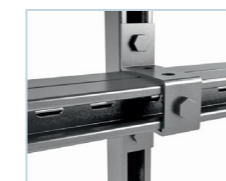

4182F

- 3/4 X T M10X30 (217547-i304) + 3/4 X TM M10 (217584-HDG)
- 3-4/50 X B3 (208827-HDG)

HDG70	
REF	MOQ
206316	1 U

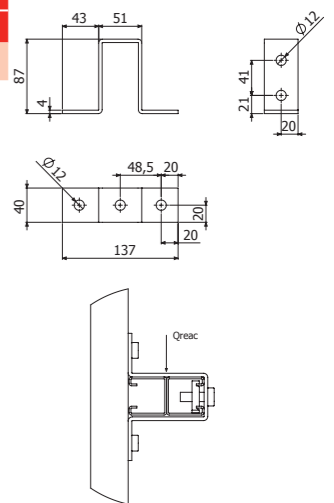

**4182G**

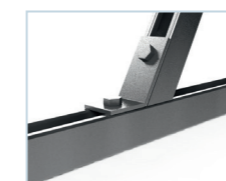

4182G

- 2 X T M10X30 (217547-i304) + 2 X TM M10 (217584-HDG)
- 2/50 x B3 (208827 - HDG)

HDG70	
REF	MOQ
206317	1 U

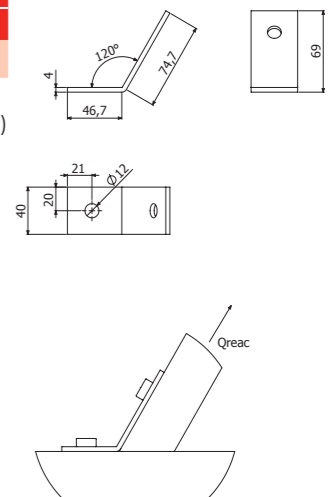

**4182H**



	Qreacc	HDG	
	kg	REF	MOQ
4182H	800	206948	1 U

- 4 X T M10X30 (217547-i304) + 4 X TM M10 (217584-HDG)
- 4/50 x B3 (208827 - HDG)

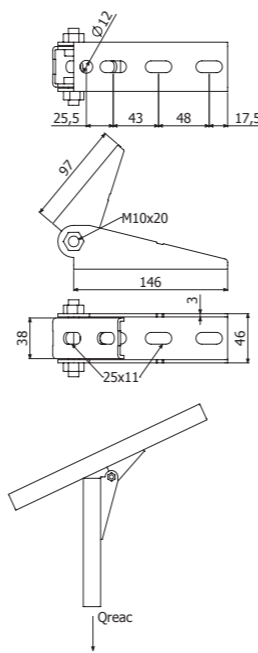

**4182I**

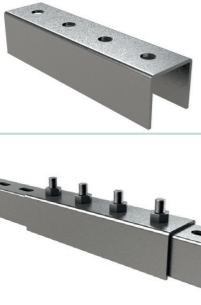

	Reducc	HDG70	
	Z	REF	MOQ
4182I	0%	207011	4 U

- 4 X T M10X30 (217547-i304) + 4 X TM M10 (217584-HDG)
- 4/50 x B3 (208827 - HDG)

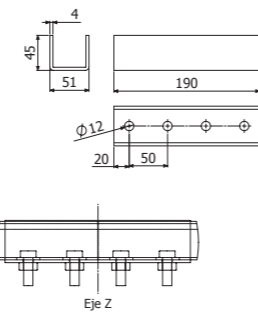

**4182J**



	Reducc	HDG70	
	Z	REF	MOQ
4182J	0%	217315	28 U

- 4 x DIN933 M10X30 (217547-i304 / 217600-i316) + 4 x TM41 M10 (217584-HDG / 218525-i304 / 217612-i316)
- 4/50 x B3 (208827-HDG / 212096-i304 / 215575-i316)

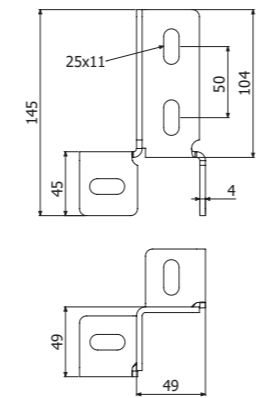

**4182K**

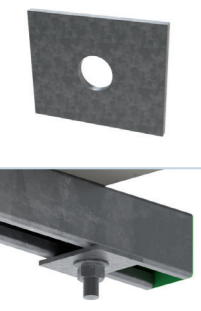

	Reducc	HDG70	
	Z	REF	MOQ
4182K	0%	218515	50 U

- M10, M12

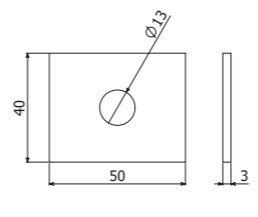

**4182L**



	Reducc	HDG70	
	Z	REF	MOQ
4182L	0%	223000	20 U

- 4 x DIN933 M10X30 (217547-i304 / 217600-i316) + 4 x TM41 M10 (217584-HDG / 218525-i304 / 217612-i316)
- 4/50 x B3 (208827-GC / 212096-i304 / 215575-i316)

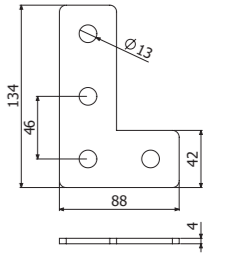

**4182M**



	Reducc	HDG70	
	Z	REF	MOQ
4182M	0%	223016	20 U

- 4 x DIN933 M10X30 (217547-i304 / 217600-i316) + 4 x TM41 M10 (217584-HDG / 218525-i304 / 217612-i316)
- 4/50 x B3 (208827-HDG / 212096-i304 / 215575-i316)

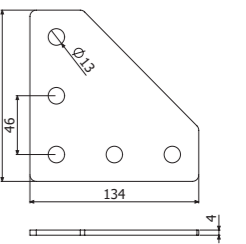

**4182N**



	Reducc	HDG70	
	Z	REF	MOQ
4182N	0%	223591	20 U

- 3 x DIN933 M10X30 (217547-i304 / 217600-i316) + 3 x TM41 M10 (217584-HDG / 218525-i304 / 217612-i316)
- 3/50 x B3 (208827 - HDG / 212096-i304 / 215575-i316)

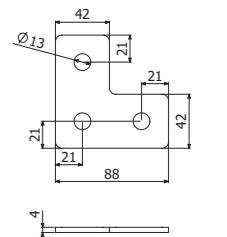

**BFT**

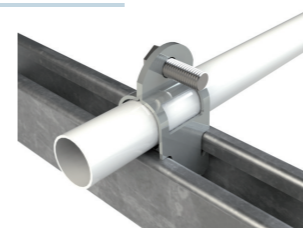

	Dn	e	EZ	
	mm	mm	REF	MOQ
BFT-41 20	17,9-20	1,5	206811	100 U
BFT-41 25	23,4-25,4	1,5	206812	100 U
BFT-41 32	29,5-32	1,5	206813	100 U
BFT-41 40	38,4-40,6	2	206814	100 U
BFT-41 50	50,3-53,7	2	206815	100 U

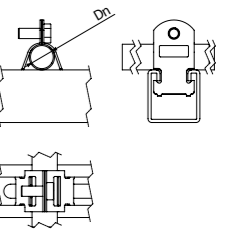

**TF41**



	PVC UVM1	
	REF	MOQ
TF41	205627	50 U

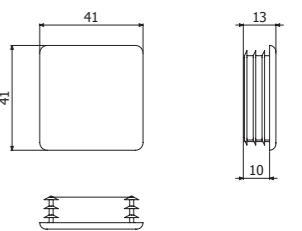

TM41



	e mm	Qtrac kg	Qcort kg	Pap N-m	EZ		HDG		i304	
					REF	MOQ	REF	MOQ	REF	MOQ
TM41 M6	6	500	100	3,5	217556	100 U	208225	100 U		
TM41 M8	6	600	240	8,4	217557	100 U	217583	100 U		
TM41 M10	8	700	350	17	217551	100 U	217584	100 U	-	-

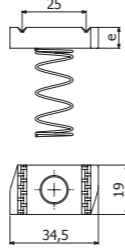

TAD



	e mm	Qtrac kg	Qcort kg	Pap N-m	EZ	
					REF	MOQ
TAD M8	6	600	240	8,4	217558	100 U
TAD M10	8	700	350	17	205543	100 U

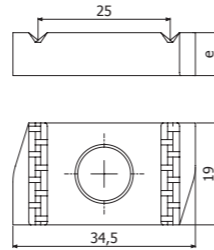

TEP



	e mm	Qtrac kg	Qcort kg	Pap N-m	EZ	
					REF	MOQ
TEP M10X30	8	700	350	17	2017567	50 U

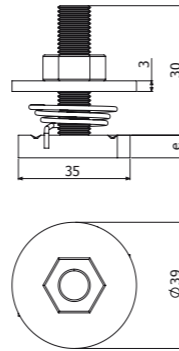

VR DIN976 & DIN934



DIN976

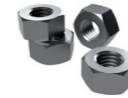

DIN934

	i304	
	REF	MOQ
DIN976 M8X85	210246	50 U
DIN976 M10X100	210247	25 U
DIN976 M10X150	210248	25 U
DIN976 M12X150	210249	1 U
DIN976 M12X200	210250	1 U

SE41



	Ø max mm	e mm	HDG	
			REF	MOQ
SE41 20-24	20-24	1,5	207355	1 U
SE41 24-28	24-28	1,5	207356	1 U
SE41 28-32	28-32	1,5	207357	1 U
SE41 32-36	32-36	1,5	207358	1 U
SE41 36-40	36-40	1,5	207359	1 U

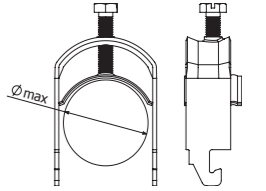

SBL



	e	PG		HDG		i304	
		REF	MOQ	REF	MOQ	REF	MOQ
SBL	3	200351	10 U	200361	10 U	200371	10 U

M8 & M10

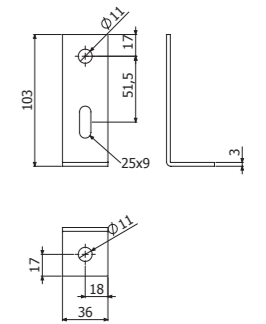

SBC

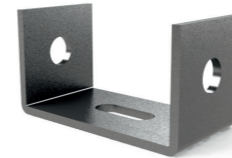

	Qreac 1 kg	Qreac 2 kg	e	PG		HDG		i304	
				REF	MOQ	REF	MOQ	REF	MOQ
SBC	40	40	3	200352	20 U	200362	10 U	200372	10 U

M8 & M10

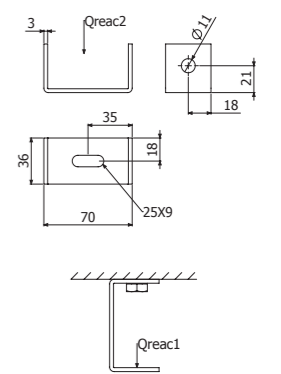

SBZ



	Qreac 1 kg	e	PG		HDG		i304	
			REF	MOQ	REF	MOQ	REF	MOQ
SBZ	35	3	200354	10 U	200364	10 U	200374	10 U

M8 & M10

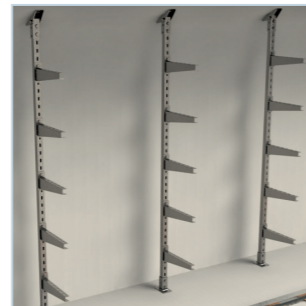
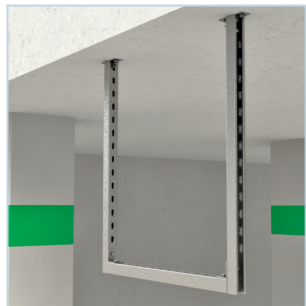
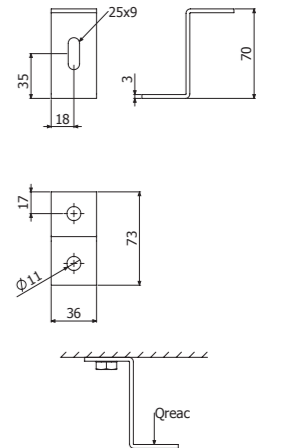

DIN933 / DIN912



DIN933



DIN912



ISO7380-2

	UVM	UVE	P	M	L	H	EZ		i304	
	ud	ud	N-m	mm	mm	mm	REF	MOQ	REF	MOQ
DIN933 M10X30	100	100	35	10	30	6,4	217559	100 U	217547	100 U
DIN933 M10X20	100	100	35	10	20	6,4	217563	100 U	217578	100 U
DIN933 M8X70	100	100	15	8	70	5,3	217564	100 U		
DIN933 M8X55	100	100	15	8	55	5,3	217566	100 U		
DIN933 M8X25	100	100	15	8	25	5,3	217545	100 U		
DIN933 M8X20	100	100	15	8	20	5,3	-	-	217546	100 U
DIN933 M6X25	100	100	8	6	25	4	205545	100 U	217549	100 U
DIN933 M6X20	100	100	8	6	20	4	-	-		
DIN912 M8X70	100	100	15	8	70	8	217580	100 U	217581	100 U
DIN912 M8X55	100	100	15	8	55	8	217577	100 U	217579	100 U
ISO7380-2 M8X30	100	100	15	8	30	4,4	-	-		
ISO7380-2 M6X25	100	100	8	6	25	3,3	217582	100 U		

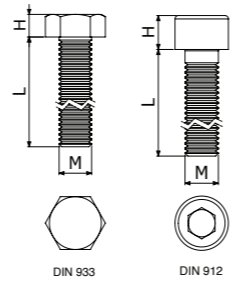

DIN 933

DIN 912

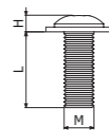

ISO 7380-2

DIN6923



	Pap	M	Dext	A	H	EZ		i304	
	N-m	mm	mm	mm	mm	REF	MOQ	REF	MOQ
DIN6923 M6	8	M6	14	10	6	217552	100 U	217554	300 U
DIN6923 M8	15	M8	18	13	8	217553	200 U	217555	100 U

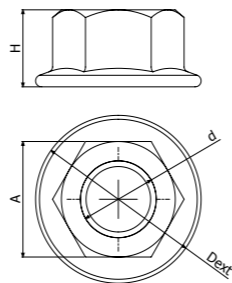

DIN125



	Dint	Dext	e	EZ		i304	
	mm	mm	mm	REF	MOQ	REF	MOQ
DIN125 M6	6,4	12	1,6	217565	1000 U	205539	1000 U
DIN125 M8	8,4	16	1,6	217541	1000 U	217544	1000 U
DIN125 M10	10,5	20	2	217561	1000 U	217542	1000 U
DIN125 M12	13	24	2,5			217560	1000 U

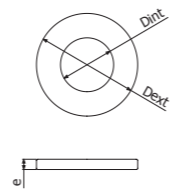

DIN9021

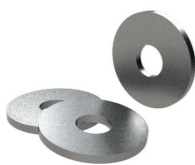

	Dint	Dext	e	EZ		i304	
	mm	mm	mm	REF	MOQ	REF	MOQ
DIN9021 M6	6,4	18	1,6	207023	200 U	207022	200 U
DIN9021 M8	8,4	24	2	207021	500 U	217543	1000 U

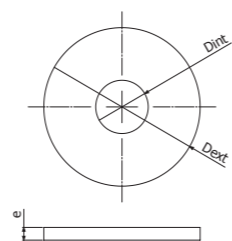

CCM



	M	L	Qtrac	EZ	
	mm	mm	kg	REF	MOQ
CCM M6X60	6	60	190	206419	100 U
CCM M8X60	8	60	320	206420	1 U

↓ 60mm, Ø 8mm (CCM 6X60) / Ø10mm (CCM 8x60)

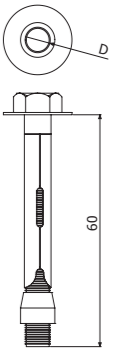

SCM



	D	L	Qtrac	EZ	
	mm	mm	kg	REF	MOQ
SCM M10X75	10	75	600	204672	50 U
SCM M12X80	12	80	1040	206258	100 U

↓ 60-70mm (SCM 10x75) - ↓ 75-90mm (SCM 12x80), Ø 10mm (SCM 10x75) / Ø12mm → (SCM 12x80)

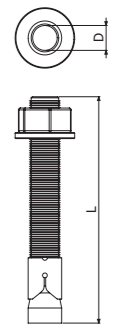

CM



	D	M	Qtrac	EZ	
	mm	mm	kg	REF	MOQ
CM M6X30	8	6	340	206468	1 U
CM M8X30	10	8	370	206469	400 U

↓ 32mm - Ø 8mm (CM 6x30) / ↓ 33mm - Ø 10mm (CM8x30)

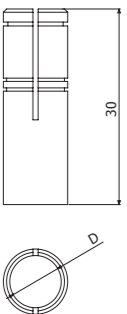

A



TDC



BPZ

	REF	MOQ
TDC	205066	1 U
BPZ 400 ml	207224	1 U

**TT / TTL**

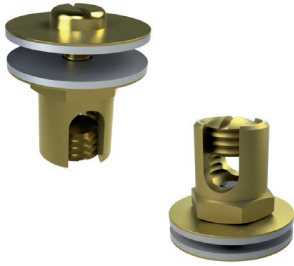

TT

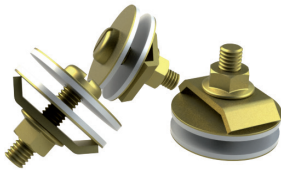

TTL

	Smin	Smax	Dcable	A	B	LTN	
	mm <sup>2</sup>	mm <sup>2</sup>	mm	mm	mm	REF	MOQ
TT 4-35	4	35	2,2 a 8	22	18	206796	10 U
TT 35-95	35	95	8 a 12	30	24	206797	10 U
TTL 10-35	10	35	4 a 8	25	-	208189	20 U

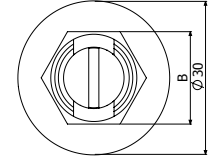
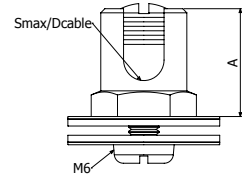

TT

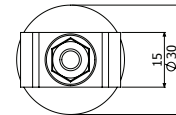
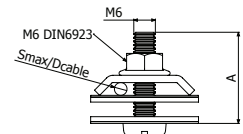

TTL



# The world is GREEN

Catalogue EU-01

**50** Countries with permanent stock  
**1300** Global distributors  
**10** Own subsidiaries

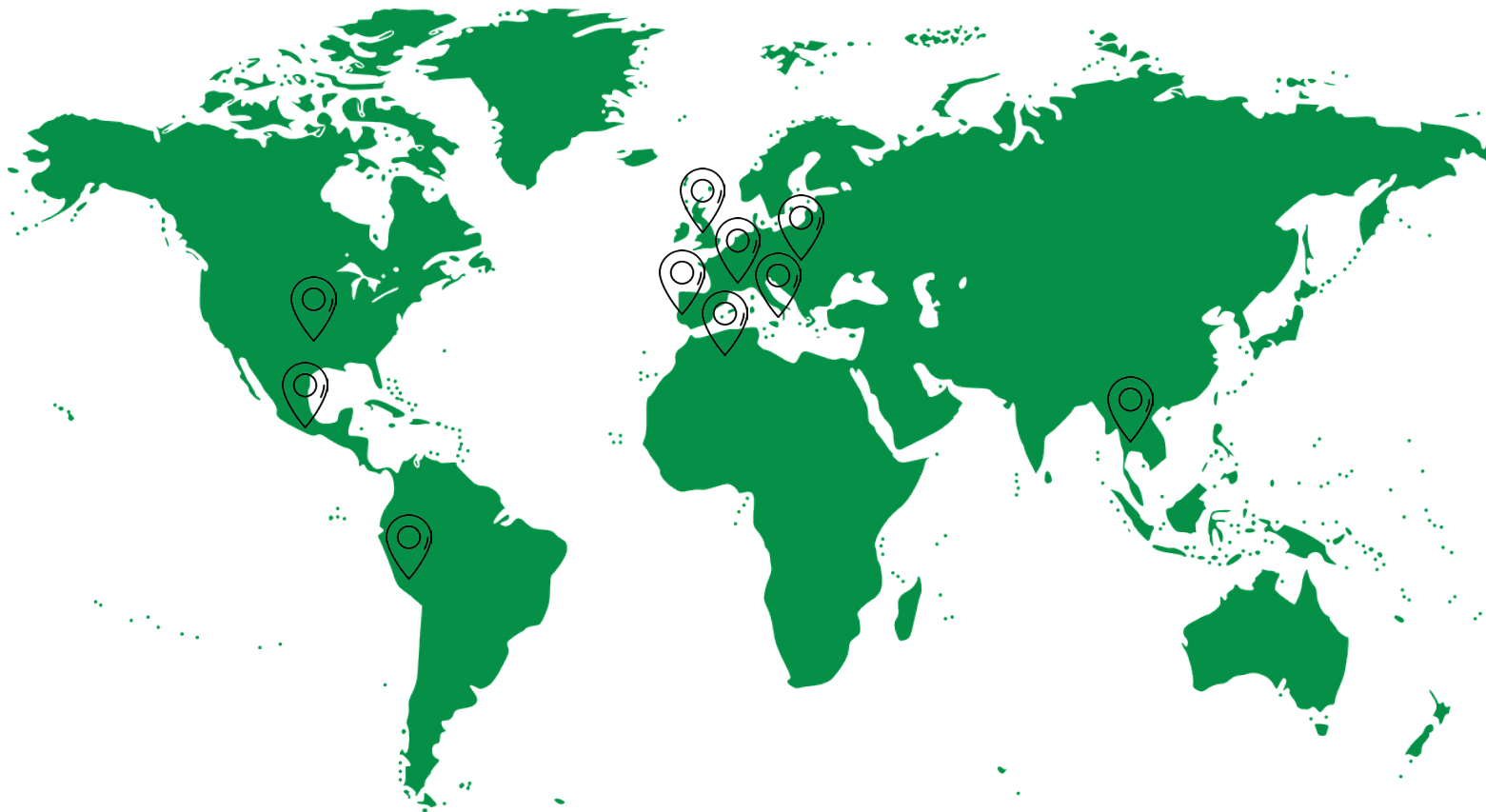

## AMERICA

**USA** Basor Electric Inc. (Illinois)

**MEXICO** Basor México SAPI de CV. (Mexico DF)

**PERU** Basor Perú SAC. (Lima)

## EUROPE

**PORTUGAL** Basor Caminho de Cabos LDA. (Barreiro)

**FRANCE** Basor SARL. (Paris)

**HUNGARY** Basor Elektro KFT. (Budapest)

**UK** Basor Electric LTD (Kent)

**ITALY** Basor Electric SRL (Parma)

## AFRICA

**ALGERIA** Basor Electric SARL. (Argel)

## ASIA

**THAILAND** BasorThai (Bangkok)

**3EBasor**  
CABLE TRAY SPECIALIST

**BEGREEN**  
CableManagementSystems

**BE Basor**  
CABLE TRAY SPECIALIST

BASOR ELECTRIC S.A Headquarters

Avenida Alcodar 45-47  
46701 Gandia SPAIN

+34 962876695  
basor@basor.com  
www.basor.com

  
@basorelectric

  
[www.linkedin.com/  
company/basor-electric-sa](https://www.linkedin.com/company/basor-electric-sa)

  
[www.youtube.com/user/  
basorelectric](https://www.youtube.com/user/basorelectric)